

697 Touchless Wall Switch INSTALLATION INSTRUCTIONS

1 Description

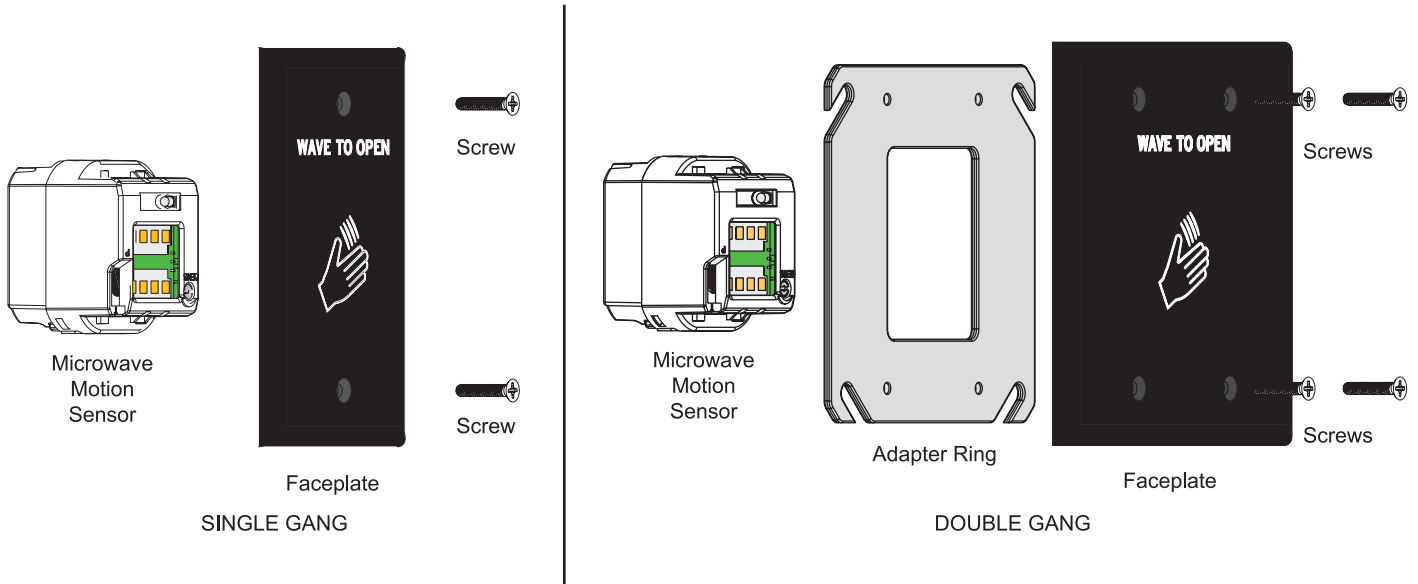

2 Specifications

DESCRIPTION	SPECIFICATION
TECHNOLOGY	Microwave motion sensor
RADIATED FREQUENCY	24.125 GHz
RADIATED POWER DENSITY	5 mW/cm ²
SUPPLY VOLTAGE	12 to 24VAC ± 10% 12 to 24VDC +30% / -10%
SUPPLY FREQUENCY	50 to 60Hz
POWER CONSUMPTION	< 1.5W
OUTPUT	Relay with switch-over contact (voltage free) Relay contact rating (max voltage) 60 VDC/ 125 VAC Relay contact rating (max current) 1A (resistive) Max switching power 30W (DC)/ 60VA (AC)
DETECTION RANGE	4" to 24" (10 cm to 60 cm) (adjustable)
DETECTION MODE	Motion (bidirectional)
OUTPUT HOLD TIME	0.5s (in pulsed mode)
TEMPERATURE RANGE	-4°F to + 131°F (-20°C to +55°C)
IMMUNITY	Immune to electrical and radio frequency interference
WEIGHT	0.34 lbs. (0.15 kg.)
MATERIAL	ASA, Nylon, PC
CERTIFICATION	Electromagnetic compatibility (EMC) according to 2004/108/EC FCC: G9B-MS08 IC: 4680A-MS08

3 Precautions



- ❑ Shut off all power going to wall outlet before attempting any wiring procedures.
- ❑ Maintain a clean & safe environment when working in public areas.
- ❑ Constantly be aware of pedestrian traffic around the door area.
- ❑ Always stop pedestrian traffic through the doorway when performing tests that may result in unexpected reactions by the door.
- ❑ ESD electrostatic discharge: Circuit boards are vulnerable to damage by electrostatic discharge. Before handling any board ensure you dissipate your body's charge.
- ❑ Always check placement of all wiring before powering up to insure that moving door parts will not catch any wires and cause damage to equipment.
- ❑ Ensure compliance with all applicable safety standards upon completion of installation.
- ❑ DO NOT attempt any internal repair of the sensor.

4 Pre-Installation Check

1. When wiring multiple devices together creating a system configuration, it is best to ensure that each device works independently. This will reduce troubleshooting if a discrepancy occurs.
2. Prior to installing any equipment in either new or existing circuits, ensure correct line voltage and line stability. Always remember to shut the power OFF before performing circuit wiring.

5 Installation / Wiring / Setup

A Installation

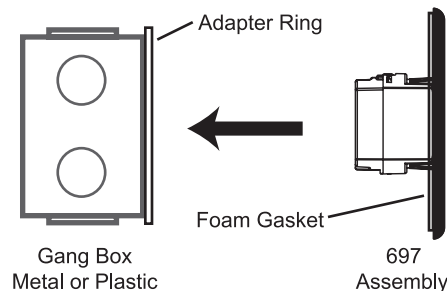
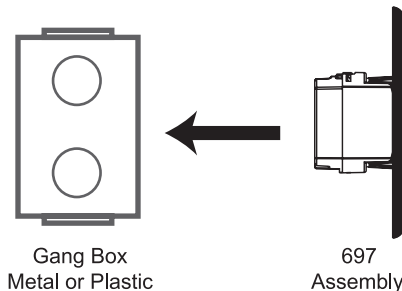

1. The 697 may be mounted in conventional metal or plastic electrical gang boxes. Make sure the unit sensor does not come in contact with the metal gang box to avoid shorting out the unit.

- Do not place the sensor in the door's opening range, where the sensor may see door movement.
- Do not place moving objects in front of the sensor.

2. Depending on the door installation, the weather resistant foam gasket or the plastic adapter ring may be used. The weather resistant foam is used as a protective barrier against the elements. The plastic adapter ring is designed to enable the double gang face plate to attach to various plastic and metal gang boxes.

B Wiring

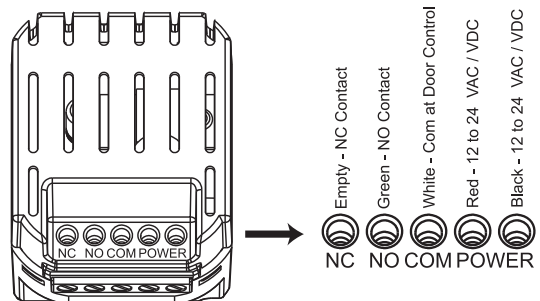
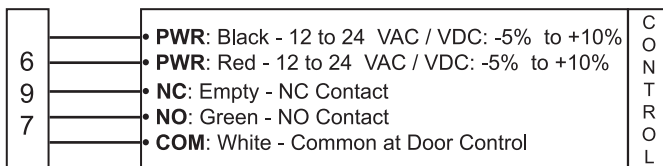

Attach the 4-conductor cable connector to the Magic Switch.

5 Installation and Wiring (Continued)

C Setup

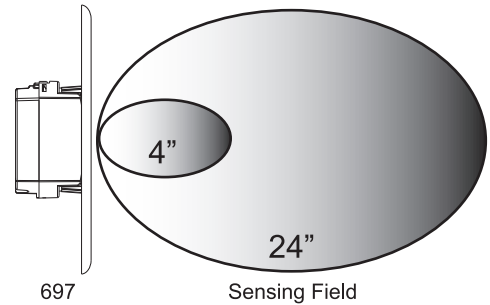
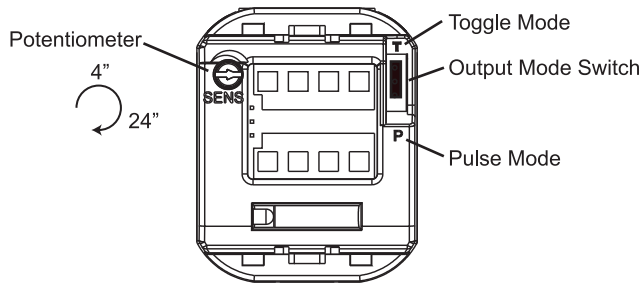

1. Adjust unit to desired setup. Two adjustments can be made to the sensor. The Potentiometer is used to adjust the size of the units' sensing field and the Output Mode switch is used to select Pulse or Toggle mode.
2. Rotate potentiometer clockwise to increase the sensing field. It may be adjusted from 4" to 24".

3. Adjust Output Mode by moving switch in the down position (Pulse Mode) or in the up position (Toggle Mode).

Pulse Mode: Recommended for automatic door applications. In Pulse mode a detection activates the relay for a short period of time - depending on the duration of movement in front of door.

Toggle Mode: Recommended for switch applications. In Toggle mode a detection activates the relay and a second detection deactivates the relay.

6 Troubleshooting

A Troubleshooting Procedures

PROBLEM	PROBABLE CAUSE	CORRECTIVE ACTION
Door does not open when swiping hand in front of sensor.	<ol style="list-style-type: none"> 1. Bad or no power supply. 2. Detection range is too small 3. Wrong connection. 	<ol style="list-style-type: none"> 1. Check power supply. If LED switches on or flashes, power connections are OK. 2. Adjust the detection range. Remove any metal plates in front of sensor. 3. Check wiring and relay connection.
Door remains permanently open.	<ol style="list-style-type: none"> 1. Environmental conditions are influencing the sensor. 2. Wrong connection. 	<ol style="list-style-type: none"> 1. Remove any moving objects close to the sensor. 2. Check wiring and relay connection.
The door remains open after detection/activation.	<ol style="list-style-type: none"> 1. Wrong output mode. 2. Wrong connection. 	<ol style="list-style-type: none"> 1. Switch the output mode to Pulse mode. 2. Check wiring and relay connection.



3000 Highway 74 East • Monroe, NC 28112
 Tel: (877)-974-2255 • Fax: (800)-338-0965
www.nortondoortcontrols.com

Norton® is a registered trademark of Yale Security Inc., an ASSA ABLOY Group company.
 Copyright © 2008, Yale Security Inc., an ASSA ABLOY Group company. All rights reserved.
 Reproduction in whole or in part without the express written permission of Yale Security Inc., an ASSA ABLOY Group company is prohibited.

ASSA ABLOY is the global leader in door opening solutions, dedicated to satisfying end-user needs for security, safety and convenience.