



# Adams Rite

## Product Pricelist

US & Canada Effective Date: May 20, 2024



ASSA ABLOY

# Adams Rite 2024 Product Pricelist

[adamsrite.com](https://adamsrite.com)

Experience a safer  
and more open world

# 2024 Pricelist Adams Rite Architectural Hardware

## DEADLOCKS

1830 Bottom Rail Deadlock (Swingbolt)	2
MS1837 Series MS® Two-Point Deadlock	2
MS1847/MS1848 Series MS® Deadlock/Deadlatch	2
MS1850S Series MS® Deadlock	3
1850S-X2X Series Short Throw Deadlock	3
MS1850SN Series MS® Deadlock (ANSI Size)	4
MS1861 Series MS® Bottom Rail Deadlock	4
1875 Two-Point Deadlock	4
MS+1890 Series MS® Deadlock/Deadlatch	5
MS1950P Series MS® Deadlock	5
2190, 2290 Dual Force® Interconnected Deadbolt/Deadlatch for Aluminum Stile Doors (2190); for Wood or Hollow Metal (2290)	6
2331 Heavy Duty Deadbolt	7
4070 Series Short Throw Deadbolt (Projection Style)	7
5017 Deadlock/Deadlatch for Wood Doors	7
5500 Deadlock for Sliding Wood Doors	7

## DEADLATCHES

DL100 Aperio® Wireless Deadlatch	8
4300 Steel Hawk® Electrified Deadlatch	8
4300 RITE Pack®	8
4510 Standard Duty Deadlatch	9
4530 Standard Duty Deadlatch	9
4781 Two-Point Deadlatch with Paddle	10
4900 Heavy Duty Deadlatch	10
4920AN Heavy Duty Deadlatch (ANSI Size)	10

## FLUSHBOLTS

1870 Cylinder-Operated Flushbolt	11
1870HM Cylinder-Operated Flushbolt	11
1877 Cylinder-Operated Flushbolt	11
MS1880, MS1881 Two-Point Flushbolts	12
MS2180 Auto-Release Two-Point Flushbolt	12
4189, 4190 Flush Locksets (Including Deadlock)	13
4430, 4431 Flush Locksets (Including Deadlock)	13

## EXIT DEVICES

8099 Dummy Pushbar	14
8100   3100 Surface Vertical Rod Exit Device	14
8200 Narrow Stile Surface Vertical Rod Exit Device	15
8300   3300 Mortise Exit Device	15
8400 Narrow Stile Mortise Exit Device	16
8500   3600 Metal Door Concealed Vertical Rod Exit Device	16
8600 Narrow Stile Concealed Vertical Rod Exit Device	17
8700   3700 Starwheel Rim Exit Device	17
8800 Narrow Stile Starwheel Rim Exit Device	18
P8800   P8700 Pullman Narrow Stile Rim Exit Device	18
8900   3900 Wood Door Concealed Vertical Rod Exit Device	19
Accessories for 8000   3000 Series Exit Devices	19
Kitted Options for 8000   3000 Series Exit Devices	19
Modification Options for 8000   3000 Series Exit Devices	19

## ELECTRIC STRIKES

7100, 7101 Electric Strikes	20
7110, 7111 Electric Strikes	20
7130, 7131 Electric Strikes	21
7140 Electric Strike	21
7160 Electric Strike	21
7170 Electric Strike	22
7100 Series Electric Strike Components	22
7240 Fire-Rated Electric Strike	23
7270 Fire-Rated Electric Strike	23
7400, 7401 UltraLine® Preload-Capable Electric Strikes	23
7410, 7411 UltraLine® Preload-Capable Electric Strikes	24
7430, 7431 UltraLine® Preload-Capable Electric Strikes	24
7440 UltraLine® Preload-Capable Electric Strike	24
74R1 UltraLine® Preload-Capable Electric Strike	25
74R2 UltraLine® Preload-Capable Electric Strike	25
7400 UltraLine® Electric Strike Components	25
7800 Series Electric Strike	26
7800 Series Electric Strike Accessories	26

## TRIM

1000 Series Turns	27
3000 Fixed Pull	27
3080 Series Entry Trim	28
3090 eForce® Keyless Entry	29
4060 Turn	29
4550 MS® Deadlock Lever	29
4560, 4565 Series Deadlatch Handles	30
4568, 4569 Eurostyle Deadlatch Handles	30
4570 ICU Latch Operator	31
4576 ICU Flushbolt Latch Operator	31
4590 Deadlatch Paddle	32
4591 Deadlatch Paddle	33
4600 Heavy Duty Designer Deadlatch Handles	34

## CYLINDERS & ACCESSORIES

4024, 4025, 4026 Cylinder Pulls	35
4036 Mortise Cylinder	35
MS4043 Cylinder Guard	36
4066 Thumbturn	36
4580 Cam Plug	36
4581 Universal Cam Plug	36
8650 Cylinder Escutcheon Kit	37
8736 Rim Cylinder	37
4014 Two-Point Conversion Kit	37
4015 Threshold Bolt	37
4016 Header Bolt	37
4085 Header Bolt (Pairs of Doors Only)	38
4089 Exit Indicator	38
4104 Mounting Bridges	38
91-0965 Universal Mounting Tab Kits for Installing	
MS® Locks & Latches	38
B1921, B1923 Reinforcing Pivots	39

### Strikes

2190 Dual Force® Interconnected Deadbolt/Deadlatch Strikes	39
2290 Dual Force® Interconnected Deadbolt/Deadlatch Strikes	39
4000 Series MS® Deadlock Strikes	39
4800, MS4804 Series Strikes	40
4901, 4902 Deadlatch Strikes	40
4304 Deadlatch Strike	40

## CYLINDERS & ACCESSORIES CONT.

<b>Thick Door Kits</b>	
2190, 2290 Dual Force® Interconnected Deadbolt/Deadlatch Thick Door Kit	41
4568, 4569 Eurostyle Deadlatch Handles Thick Door Kits	41

### Faceplates

MS1850S Deadlocks Faceplates	41
MS1850S, MS1950P Deadlock (Standard Bolt) Faceplates	41
MS1850S, MS1950P Deadlock (Hookbolt and Short Bolt) Faceplates	42
MS1850SN410 Deadlock (Standard Bolt) Faceplates	42
MS1850SN450 Deadlock (Hookbolt) Faceplates	42
1870 Flushbolt Faceplates	42
MS+1890 Deadlock Faceplates	42
2190 Dual Force® Interconnected Deadbolt/Deadlatch Faceplates	43
2331 Heavy Duty Deadbolt Faceplates	43
3300 Fire-Rated Mortise Exit Device Faceplates	43
4070 Short Throw Deadbolt Faceplates	43
4500 Standard Duty Deadlatch Faceplates	43
4530 Standard Duty Deadlatch Faceplates	43
4900 Heavy Duty Deadlatch Faceplates	43
4900 Heavy Duty Deadlatch Special Faceplates	44
4920, 8300 Faceplates	44
7100, 7160 Electric Strike Faceplates	44
7101 Electric Strike Faceplates	44
7110 Electric Strike Faceplates	44
7111 Electric Strike Faceplates	44
7130 Electric Strike Faceplates	44
7131 Electric Strike Faceplates	44
7140, 7170 Electric Strike Faceplates	44

## POWER

PS-1 Power Supply	45
PS-EXIT Power Supply*	45
4612 Power Transfer Device	45
Accessories for Power	45

\*PS-EXIT has replaced the PS-LR and PS-SE power supplies

## DEMO MOUNTS

### Deadlocks & Deadlatches

2190 Dual Force® Interconnected Deadbolt/Deadlatch	46
4300 Steel Hawk® Electrified Deadlatch	46
DL100 Aperio® Wireless Deadlatch	46

### Electric Strikes

7400 UltraLine® Electric Strikes	46
----------------------------------	----

### Trim

3090 eForce® Keyless Entry	46
4600 Heavy Duty Designer Deadlatch Handles	46

## GENERAL INFORMATION

Adams Rite Limited Warranty/Terms and Conditions	47
--------------------------------------------------	----



# DEADLOCKS

## 1830 Bottom Rail Deadlock (Swingbolt)

MODEL	DESCRIPTION	313, 628
1830	Deadlock with 31/32" or 1-1/8" cylinder height	\$161



**How to Order** Specify quantity and the following information. Order related products separately.

PRODUCT NO.	DASH NO. (SPECIFY FOR CYLINDER HEIGHT AND LOCK DEPTH)	FINISH
1830	-02	-628
	02 Cylinder Height 31/32" Dim. "A" 1-5/8"	628 Clear Anodized
	03 Cylinder Height 1-1/8" Dim. "A" 1-25/32"	313 Dark Bronze Anodized

## MS1837 Series MS® Two-Point Deadlock

MODELS	DESCRIPTION & FINISHES	313, 335, 628	605, 626
MS1837	Deadlock includes 4001-011 strike, 36" cylinder height	\$284	\$382
MS1837	Deadlock includes 4001-011 strike, contact factory for cylinder height other than 36" up to maximum cylinder height 65"	\$347	\$445



**How to Order** Specify quantity and the following information. Order related products separately.

PRODUCT NO.	FINISH
MS1837	-313
	313 Dark Bronze Anodized
	335 Black Anodized
	605 Bright Brass
	626 Satin Chrome
	628 Clear Anodized

*If cylinder height other than 36" is required, specify exact height from bottom of door to cylinder center. Maximum cylinder height 65".*

## MS1847/MS1848 Series MS® Deadlock/Deadlatch

MODEL	DESCRIPTION & FINISH	630
MS1847	Deadlock/deadlatch, stainless steel	\$75
MS1848	Deadlock/deadlatch, steel	\$45



**How to Order** Specify quantity and the following information. Order related products separately.

PRODUCT NO.	FACE SHAPE, HUB ANGLE, LOCK OR LATCH	FINISH
MS1847 MS1848	-02 (See Configuration table below)	-630
		630 Satin Stainless (MS1847 only)

## MS1850S Series MS® Deadlock

MODELS	DESCRIPTION & BACKSETS	7/8"	31/32", 1-1/8", OR 1-1/2"
MS1850S	Flat faceplate, 313, 335, or 628 finish, without strike plate	\$94	\$80
MS1851S	Radius faceplate, 313, 335, or 628 finish, without strike plate	\$94	\$80
MS1851SW	Radius faceplate with weatherstrip, 313, 335, or 628 finish, without strike plate	\$100	\$85
MS1852S	Bevel faceplate, 313, 335, or 628 finish, without strike plate	\$94	\$80
SPECIAL MODEL			
MS1853S-XXX-IB	Without faceplate, without strike plate	\$83	\$70

Schoolhouse function for above deadlocks add \$39. Please contact factory for more information.



### How to Order

Specify quantity and the following information. Order related products separately.

PRODUCT NO.	FACEPLATE	BACKSET	BOLT SHAPE	HANDING	FINISH
MS185	OS	-2	1	0	-628
	OS Flat	1 7/8"	1 Straight bolt	0 Non-Handed*	313 Dark Bronze Anodized
	1S Radius	2 31/32"	5 Hookbolt	5 LH or RHR	335 Black Anodized
	1SW Radius with weatherstrip	3 1-1/8"		6 RH or LHR	628 Clear Anodized
	2S Bevel	4 1-1/2"			
	3S Without faceplate, without strike plate				

\*Any flat or radius faceplate, except Schoolhouse. Select handing for bevel faceplate only. \*"SCHOOLHOUSE" version, also available, is modified so that operation from inside is "unlock only". This lock is handed and must be specified LH/RHR or RH/LHR. Specify SCH1850SN or SCH1850SN-450 Series. Same faceplate and backset options as MS1850SN or MS1850SN-450 Series.

## 1850S-X2X Series Short Throw Deadlock

MODELS	DESCRIPTION & FINISHES	313, 335, 628
1850S	Flat faceplate, 31/32", 1-1/8", or 1-1/2" backset, without strike plate	\$80
1851S	Radius faceplate, 313, 335, or 628 finish, without strike plate	\$80
1852S	Bevel faceplate, any handing, 313, 335, or 628 finish, without strike plate	\$80
SPECIAL MODEL	DESCRIPTION	PRICE
1853S-X20-IB	WITHOUT faceplate, without strike plate	\$70



### How to Order

Specify quantity and the following information. Order related products separately.

PRODUCT NO.	FACEPLATE	BACKSET	BOLT SHAPE	HANDING	FINISH
185	OS	-2	2	0	-628
	OS Flat	2 31/32"	2 Short Throw	0 Non-Handed*	313 Dark Bronze Anodized
	1S Radius	3 1-1/8"		5 LH or RHR	335 Black Anodized
	2S Bevel	4 1-1/2"		6 RH or LHR	628 Clear Anodized
	3S Without faceplate, without strike plate				

\*Any flat or radius faceplate, except Schoolhouse. Select handing for bevel faceplate only.

## MS1850SN Series MS® Deadlock (ANSI Size)

MODELS	DESCRIPTION & FINISH	313, 335, 628
MS1850SN410	Flat faceplate, 1-1/2" backset, without strike plate	\$125
MS1850SN450	Radius faceplate, 1-1/2" backset, without strike plate	\$125

**How to Order** Specify quantity and the following information. Order related products separately.

PRODUCT NO.	FACEPLATE	ANSI SIZE	BOLT SHAPE	FINISH
MS185	0	SN	410	-628
	0 Flat		410 Straight bolt	313 Dark Bronze Anodized
	1 Radius		450 Hookbolt	335 Black Anodized
				628 Clear Anodized



## MS1861 Series MS® Bottom Rail Deadlock

MODELS	DESCRIPTION & FINISH	603
MS1861-01	One-point deadlock, vertical bolt operation only	\$168
MS1861-02	Two-point deadlock, horizontal and vertical operation	\$210

**How to Order** Specify quantity and the following information. Order related products separately.

PRODUCT NO.	BOLT OPERATION	FINISH	PACKAGING
MS1861	-01	-603	-IB
	01 Vertical Bolt Only	603 Zinc plated steel	IB Individually Boxed
	02 Vertical and Horizontal Bolts		

*If tube spacers (26-009) are required please specify quantity and length.*



## 1875 Two-Point Deadlock

MODEL	DESCRIPTION & FINISH	603
1875	Two-point deadlock for roll-up doors	\$214

**How to Order** Specify quantity and the following information. Order related products separately.

PRODUCT NO.	PACKAGING
1875	-IB
	IB Individually Boxed



## MS+1890 Series MS® Deadlock/Deadlatch

MODELS & FINISHES		313, 335, 628
MS+1890	Flat faceplate, 31/32", 1-1/8", or 1-1/2" backset	\$285
MS+1891	Radius faceplate, 31/32", 1-1/8", or 1-1/2" backset	\$285
MS+1891W	Radius faceplate with weatherstrip, 31/32", 1-1/8", or 1-1/2" backset	\$299
MS+1892	Bevel faceplate, any handing, 31/32", 1-1/8", or 1-1/2" backset	\$285
SPECIAL MODELS		
MS+1890, MS+1891, MS+1892	Flat, radius, or bevel faceplate, complete with flat / center hung 4" or 4-1/2" strike plate	\$300
MS+1890-XX-XXX	Without strike plate	\$232
MS+1893-XX-IB	Without faceplate, without strike plate	\$210



**How to Order** Specify quantity and the following information. Order related products separately.

PRODUCT NO.	FACEPLATE	BACKSET	STRIKE SHAPE/LIP LENGTH	HANDING	FINISH
MS+189	1	-3	02	6	-628
	0 Flat	2 31/32"	01 Flat/Standard Jamb	5 LH or RHR	313 Dark Bronze Anodized
	1 Radius	3 1-1/8"	02 Radius/Standard Stile	6 RH or LHR	335 Black Anodized
	1W Radius with weatherstrip	4 1-1/2"	17 Flat/Center Hung 4" Jamb		628 Clear Anodized
	2 Bevel		21 Flat/Center Hung 4-1/2" Jamb		
	3 Without faceplate, without strike plate				

*For door thickness other than 1-3/4" please contact factory.*

## MS1950P Series MS® Deadlock

MODELS		313, 335, 628
MS1950P	Flat faceplate, 31/32", 1-1/8", or 1-1/2" backset, without strike plate	\$146
MS1951P	Radius faceplate, 31/32", 1-1/8", or 1-1/2" backset, without strike plate	\$146
MS1951WP	Radius faceplate with weatherstrip, 31/32", 1-1/8", or 1-1/2" backset, without strike plate	\$151
MS1952P	Bevel faceplate, any handing, 31/32", 1-1/8", or 1-1/2" backset, without strike plate	\$146
SPECIAL MODEL		
MS1953P-XXX-IB	Without faceplate, without strike plate	\$137

*Schoolhouse function for above deadlocks add \$39. Please contact factory for more information.*

**How to Order** Specify quantity and the following information. Order related products separately.

PRODUCT NO.	FACEPLATE	BACKSET	BOLT SHAPE	HANDING	FINISH
MS195	0	-2	1	0	-628
	0P Flat	2 31/32"	1 Straight bolt	0 Non-Handed*	313 Dark Bronze Anodized
	1P Radius	3 1-1/8"	5 Hookbolt	5 LH or RHR	335 Black Anodized
	1WP Radius with weatherstrip	4 1-1/2"		6 RH or LHR	628 Clear Anodized
	2P Bevel				
	3P Without faceplate, without strike plate				

*\*Any flat or radius faceplate, except Schoolhouse.*





## 2190, 2290 Dual Force®

Interconnected Deadbolt/Deadlatch for Aluminum Doors (2190); for Wood or Hollow Metal Doors (2290)

	MODELS & TRIM SETS	STANDARD TRIM SET		ELECTRIFIED TRIM SET		LOW PROFILE TRIM	
		10B, US4, US32D	US3, US32	10B, US4, US32D	US3, US32	10B, US4, US32D	US3, US32
DESIGNER LEVER	2190, 2290 Deadbolt/Deadlatch with standard lever (01, 02, 03), complete with strike plate	\$724	\$823	\$913	\$1,012	\$641	\$740
	2190, 2290 Deadbolt/Deadlatch with standard lever (01, 02, 03), without strike plate	\$691	\$790	\$880	\$979	\$608	\$707
	2190, 2290 Deadbolt/Deadlatch with designer lever series (MD through MW), complete with strike plate	\$779	\$878	\$968	\$1,067	\$696	\$795
	2190, 2290 Deadbolt/Deadlatch with designer lever series (MD through MW), without strike plate	\$746	\$845	\$935	\$1,034	\$663	\$762
MODELS & FINISHES		313, 335, 628				N/A	
2190, 2290 Boxed lock less lever trim, with adjustable faceplate and choice of standard or radius strike		\$354					
EK-2190 Electrification Kit for 2190, 2290; 12/24 VAC/VDC (not compatible with low profile trim)						\$212	
2190-X0X-000 Less lever trim, with adjustable faceplates, less strike plate						\$321	



**How to Order** Specify quantity and the following information. Order related products separately.

PRODUCT NO.	BACKSET	STRIKE	FACEPLATE FINISH	TRIM*	HANDLE DESIGNATION	TRIM AND HANDLE FINISH
2190	-3	1	1	-1	01	32D
	3 1-1/8"	0 None	1 Clear Anodized 628	0 None	00 No Handle	03 Bright Brass (US3)
	4 1-1/2"	1 Standard Flat 2 Radius Strike	2 Dark Bronze Anodized 313	1 With Trim Set	STANDARD SERIES:	
			3 Black Anodized 335	2 With Electrified Trim Set	01 Curve	10B Dark Bronze
				3 Low Profile Trim	02 Round	32 Bright Stainless (US32)
					03 Square	32D Satin Stainless (US32D)
					DESIGNER SERIES:	
					MD MG MJ MV (Handed)	
				ME MI MN (Handed) MW		

▲ Standard and electrified trim sets are for out-swinging doors only. Low profile trim set for in-swinging doors only.

**How to Order** Specify quantity and the following information. Order related products separately.

PRODUCT NO.	BACKSET	STRIKE	FACEPLATE FINISH	TRIM*	HANDLE DESIGNATION	TRIM AND HANDLE FINISH
2290	-3	1	1	-1	01	32D
	3 1-1/8"	0 None	0 US to match trim finish	0 None	00 No Handle	03 Bright Brass (US3)
	4 1-1/2"	1 Standard Flat	1 Clear Anodized 628	1 With Trim Set	STANDARD SERIES:	
			2 Dark Bronze Anodized 313	2 With Electrified Trim Set	01 Curve	10B Dark Bronze
			3 Black Anodized 335	3 Low Profile Trim	02 Round	32 Bright Stainless (US32)
					03 Square	32D Satin Stainless (US32D)
					DESIGNER SERIES:	
					MD MG MJ MV (Handed)	
				ME MI MN (Handed) MW		

▲ Standard and electrified trim sets are for out-swinging doors only. Low profile trim set for in-swinging doors only.



US [adamsrite.com](http://adamsrite.com) | 800 872 3267 | [customerservice.adamsrite@assaabloy.com](mailto:customerservice.adamsrite@assaabloy.com)  
 CANADA [assaabloydss.ca](http://assaabloydss.ca) | 800 461 3007 | [sales.dss.ca@assaabloy.com](mailto:sales.dss.ca@assaabloy.com)

Patent pending and/or patent [www.assaabloydss.com/patents](http://www.assaabloydss.com/patents). Copyright © 2024, Hanchett Entry Systems, Inc., an ASSA ABLOY Group company. All rights reserved. Reproduction in whole or in part without the express written permission of Hanchett Entry Systems, Inc. is prohibited.

UPDATED April 16, 2024



## 2331 Heavy Duty Deadbolt

MODEL & FINISHES	121, 626	605, 625
2331 Deadbolt, 1-3/4" backset, complete with strike	\$361	\$396

### How to Order

Specify quantity and the following information. Order related products separately.

PRODUCT NO.	FINISH
2331	-626
	121 To Match 313 Dark Bronze Anodized
	605 Bright Brass
	625 Bright Chrome
	626 Satin Chrome



## 4070 Series Short Throw Deadbolt (Projection Style)

MODELS & FINISHES	313, 335, 628
4070 Flat faceplate, 7/8", 31/32", or 1-1/8" backset, without strike plate	\$199
4071 Radius faceplate, 7/8", 31/32", or 1-1/8" backset, without strike plate	\$199
4072 Bevel faceplate, any handing, 7/8", 31/32", or 1-1/8" backset, without strike plate	\$199
SPECIAL MODEL	
4073-XX-IB Without faceplate, without strike plate	\$186

### How to Order

Specify quantity and the following information. Order related products separately.

PRODUCT NO.	FACEPLATE	BACKSET	HANDING	FINISH
407	2	-2	6	-628
	0 Flat	1 7/8"	0 Non-Handed*	313 Dark Bronze Anodized
	1 Radius	2 31/32"	5 LH or RHR	335 Black Anodized
	2 Bevel	3 1-1/8"	6 RH or LHR	628 Clear Anodized
	3 Without faceplate, without strike plate			

\*Any flat or radius faceplate. Select handing for bevel faceplate only.



## 5017 Deadlock/Deadlatch for Wood Doors

MODELS & FINISH	630
5017-00 Standard stainless steel deadlock	\$73
5017-02 Self-latching deadlock/deadlatch	\$73

### How to Order

Specify quantity and the following information. Order related products separately.

PRODUCT NO.	LATCH CONFIGURATION
5017	-00
	00 Standard
	02 Self Latching



## 5500 Deadlock for Sliding Wood Doors

MODELS	119, 626
5500-20 Lockset, strike, and trim included for 1-1/4", sliding wood doors	\$158

### How to Order

Specify quantity and the following information. Order related products separately.

PRODUCT NO.	DOOR THICKNESS	FINISH
5500	-20	-626
	20 1-1/4" Thick	626 Satin Chrome
		119 to Match 335 Black Anodized



# DEADLATCHES

## DL100 Aperio® Wireless Deadlatch Kit

MODELS & FINISHES		313, 335, 628
DL100	DL100 Pre-Paired Kit with AH20 Hub – IPS Credential Option Electrified deadlatch 31/32", 1-1/8", or 1-1/2" backset	\$1,650
ACC10	RFID Test Credentials	\$35

**How to Order** Specify quantity and the following information. Order related products separately.

PRODUCT NO.	BACKSET	STRIKE	STRIKE SHAPE/ LIP LENGTH	OPTIONS	CREDENTIAL	FACEPLATE FINISH
DL100	-3	2	01	H	-IPS	-628
Monitoring & DPS are Standard Features	2 31/32"	1 Surface Mount (4304)	01 Flat/Standard Jamb	(blank) Lock & Reader	IPS (HID multiCLASS SE + HID NFC Mobile Access Enabled)	313 Dark Bronze Anodized
	3 1-1/8"	2 Mortised (4901) 4-5/8	02 Radius/Standard Stiles	H Wholesale Kit*	IPEXXXXX** (HID iCLASS ELITE + HID NFC Mobile Access Enabled)	335 Black Anodized
	4 1-1/2"		17 Flat/Center Hung 4" Jamb		BIPXXXXX** (HID BLE multiCLASS SE + HID NFC Mobile Access Enabled)	628 Clear Anodized
		21 Flat/Center Hung 4-1/2" Jamb	BIPEXXXXX** (HID iCLASS ELITE + HID BLE & NFC Mobile Access Enabled)			

\*Available only with IPS option. \*\*XXXXX is a unique or customer specific key that is only re-orderable for that specific company.  
NOTE: Paddles and levers available separately, see 4591 and 4600 for more information.



## 4300 Steel Hawk® Electrified Deadlatch

MODELS & FINISHES		313, 335, 628
4300	Electrified deadlatch 31/32", 1-1/8", or 1-1/2" backset	\$509
4300M	Monitored option, 31/32", 1-1/8", or 1-1/2" backset	\$580
SPECIAL MODELS		
4300	Electrified deadlatch complete with flat / center hung 4" or 4-1/2" strike plate	\$531
4300M	Electrified deadlatch with monitored option, complete with flat / center hung 4" or 4-1/2" strike plate	\$602

**How to Order** Specify quantity and the following information. Order related products separately.

PRODUCT NO.	BACKSET	MONITORING	STRIKE	STRIKE SHAPE/LIP LENGTH	FACEPLATE FINISH
4300	-3	M	-2	01	-628
	2 31/32"	0 None	1 Surface Mount (4304)*	01 Flat/Standard Jamb	313 Dark Bronze Anodized
	3 1-1/8"	M Monitored	2 Mortised (4901) 4-5/8	02 Radius/Standard Stiles**	335 Black Anodized
	4 1-1/2"			17 Flat/Center Hung 4" Jamb**	628 Clear Anodized
				21 Flat/Center Hung 4-1/2" Jamb**	

\*Only available as flat standard. \*\* See ACCESSORIES for available 4901 strike options.



## 4300 RITE Pack®

MODELS		313, 628
4300-20	31/32" backset, flat and radius, 313 and 628 finish faceplates, surface mount or mortise strike	\$521
4300-30	1-1/8" backset, flat and radius, 313 and 628 finish faceplates, surface mount or mortise strike	\$521

**How to Order** Specify quantity and the following information. Order related products separately.

PRODUCT NO.	BACKSET	MONITORING	STRIKE	RITE PACK
4300	-3	0	-1	RP
	2 31/32"	0 None	1 Surface Mount (4304)	
	3 1-1/8"		2 Mortised (4901) 4-5/8"	

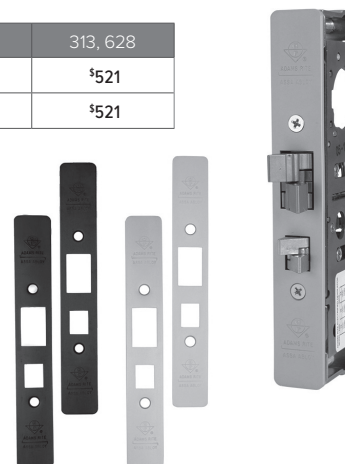

US [adamsrite.com](http://adamsrite.com) | 800 872 3267 | [customerservice.adamsrite@assaabloy.com](mailto:customerservice.adamsrite@assaabloy.com)  
CANADA [assaabloydss.ca](http://assaabloydss.ca) | 800 461 3007 | [sales.dss.ca@assaabloy.com](mailto:sales.dss.ca@assaabloy.com)

Patent pending and/or patent [www.assaabloydss.com/patents](http://www.assaabloydss.com/patents). Copyright © 2024, Hanchett Entry Systems, Inc., an ASSA ABLOY Group company. All rights reserved. Reproduction in whole or in part without the express written permission of Hanchett Entry Systems, Inc. is prohibited.

## 4510 Standard Duty Deadlatch

MODELS & FINISHES	313, 335, 628
4510 Flat faceplate, 7/8", 31/32", 1-1/8", or 1-1/2" backset, complete with strike plate	\$102
4511 Radius faceplate, 7/8", 31/32", 1-1/8", or 1-1/2" backset, complete with strike plate	\$102
4511W Radius faceplate with weatherstrip, 7/8", 31/32", 1-1/8", or 1-1/2" backset, complete with strike plate	\$107
4512 Bevel faceplate, 7/8", 31/32", 1-1/8", or 1-1/2" backset, complete with strike plate	\$102
SPECIAL MODELS	
4510, 4511, 4512 Flat, radius or bevel faceplate complete with flat / center hung 4" or 4-1/2" strike plate	\$123
4511W Radius faceplate with weatherstrip complete with flat / center hung 4" or 4-1/2" strike plate	\$128
4510, 4511, 4512 With faceplate, without strike plate	\$80
4511W Radius faceplate with weatherstrip, without strike plate	\$85
4513-XX-IB Without faceplate, without strike plate	\$70



**How to Order** Specify quantity and the following information. Order related products separately.

PRODUCT NO.	FACEPLATE	BACKSET	HANDING	STRIKE SIZE	STRIKE SHAPE/LIP LENGTH	FACEPLATE FINISH
451	1	-3	6	-2	01	-628
	0 Flat	1 7/8"	5 LH or RHR	1 Mortised (4901) 4-5/8"	01 Flat/Standard Jamb	313 Dark Bronze Anodized
	1 Radius	2 31/32"	6 RH or LHR	2 Mortised (4902) 2-5/8"	02 Radius/Standard Stiles	335 Black Anodized
	1W Radius with weatherstrip	3 1-1/8"			17 Flat/Center Hung 4" Jamb	628 Clear Anodized
	2 Bevel	4 1-1/2"			21 Flat/Center Hung 4-1/2" Jamb	
	3 Without faceplate, without strike plate					

## 4530 Standard Duty Deadlatch

MODELS & FINISHES	313, 335, 628
4530 Flat faceplate, 7/8", 31/32", or 1-1/8" backset, complete with strike plate	\$151
4531 Radius faceplate, 7/8", 31/32", or 1-1/8" backset, complete with strike plate	\$151
4532 Bevel faceplate, 7/8", 31/32", or 1-1/8" backset, complete with strike plate	\$151
SPECIAL MODELS	
4530, 4531, 4532 Flat, radius or bevel faceplate complete with flat / center hung 4" or 4-1/2" strike plate	\$181
4530, 4531, 4532 With faceplate without strike plate	\$125
4533-XX-IB Without faceplate, without strike plate	\$74



**How to Order** Specify quantity and the following information. Order related products separately.

PRODUCT NO.	FACEPLATE	BACKSET	HANDING	STRIKE SIZE	STRIKE SHAPE/LIP LENGTH	FACEPLATE FINISH
453	1	-3	6	-1	01	-628
	0 Flat	1 7/8"	5 LH or RHR	1 Mortised (4901) 4-5/8"	01 Flat/Standard Jamb	313 Dark Bronze Anodized
	1 Radius	2 31/32"	6 RH or LHR	2 Mortised (4902) 2-5/8"	02 Radius/Standard Stiles	335 Black Anodized
	2 Bevel	3 1-1/8"			17 Flat/Center Hung 4" Jamb	628 Clear Anodized
	3 Without faceplate, without strike plate				21 Flat/Center Hung 4-1/2" Jamb	

## 4781 Two-Point Deadlatch with Paddle

MODEL & FINISHES	313, 335, 628	US26D
4781 Paddle includes dogging feature	\$384	\$514
4781T Paddle with top rod only (less bottom rod)	\$348	\$488

### How to Order

Specify quantity and the following information. Order related products separately.

PRODUCT NO.		OPERATION	PADDLE FINISH
4781	T	-021	-628
	T Top rod only	021 Push to LEFT	313 Dark Bronze Anodized
	- Standard rod	041 Push to RIGHT	335 Black Anodized
			628 Clear Anodized
			US26D Satin Chrome



## 4900 Heavy Duty Deadlatch

MODELS & FINISHES	313, 335, 628
4900 Flat and radius faceplates, 31/32", 1-1/8", or 1-1/2" backset, complete with strike plate	\$139
4911W Radius with weatherseal faceplate, 31/32", 1-1/8", or 1-1/2" backset, complete with strike plate	\$146
SPECIAL MODELS	
4900 Flat and radius faceplates complete with flat / center hung 4" or 4-1/2" strike plate	\$162
4911W Radius with weatherstrip faceplate complete with flat / center hung 4" or 4-1/2" strike plate	\$169
4900 Flat and radius faceplate, without strike plate	\$116
4911W Radius with weatherstrip faceplate, without strike plate	\$123
4913-XX-IB Without faceplate, without strike plate	\$97



How to Order Specify quantity and the following information. Order related products separately.

PRODUCT NO.	FACEPLATE	BACKSET	HANDING	STRIKE SIZE	STRIKE SHAPE/LIP LENGTH	FACEPLATE FINISH
49	00	-3	5	-2	01	-628
	00 Standard	2 31/32"	5 LH or RHR	1 Mortised (4901) 4-5/8"	01 Flat/Standard Jamb	313 Dark Bronze Anodized
	11W Radius with Weatherstrip	3 1-1/8"	6 RH or LHR	2 Mortised (4902) 2-5/8"	02 Radius/Standard Stile	335 Black Anodized
	13 Without faceplate, without strike plate	4 1-1/2"			17 Flat/Center Hung 4" Jamb	628 Clear Anodized
					21 Flat/Center Hung 4-1/2" Jamb	

## 4920AN Heavy Duty Deadlatch (ANSI Size)

MODELS & FINISHES	313, 335, 628
4920AN Flat faceplate, 1-1/2" or 2-3/4" backset, complete with 4506 strike plate	\$175
SPECIAL MODELS	
4920AN Flat faceplate, without strike plate	\$126
4923AN-XX-IB Without faceplate, without strike plate	\$95

How to Order Specify quantity and the following information. Order related products separately.

PRODUCT NO.	FACEPLATE	BACKSET	HANDING	STRIKE	FACEPLATE FINISH
492	0AN	4	6	-602	-313
	0AN Flat	4 1-1/2"	5 LH or RHR	000 Less Strike	313 Dark Bronze Anodized
	3AN Without faceplate, without strike plate	5 2-3/4"	6 RH or LHR	602 4506 Strike	335 Black Anodized
					628 Clear Anodized



# FLUSHLOCKS

## 1870 Cylinder-Operated Flushbolt

MODELS & CYLINDER HEIGHT	STANDARD 12" CYLINDER HEIGHT	CYLINDER HEIGHT OVER 12" (SPECIFY)
1870 Flat faceplate, 313, 335, or 628 finish	\$149	\$206
1871 Radius faceplate, 313, 335, or 628 finish	\$149	\$206
1871W Radius faceplate with weatherstrip, 313, 335, or 628 finish	\$155	\$212
1872 Bevel faceplate, 313, 335, or 628 finish	\$149	\$206

For cylinder height greater than 12" up to maximum cylinder height 65" please contact factory.

**How to Order** Specify quantity and the following information. Order related products separately.

PRODUCT NO.	FACEPLATE SHAPE	BACKSET	HANDING*	FINISH
187	0	-2	0	-628
	0 Flat	2 31/32"	0 Non-Handed*	313 Dark Bronze Anodized
	1 Radius	3 1-1/8"	5 LH or RHR	335 Black Anodized
	1W Radius with weatherstrip		6 RH or LHR	628 Clear Anodized
	2 Bevel			

\*Any flat or radius faceplate. Select handing for bevel faceplate only.



## 1870HM Cylinder-Operated Flushbolt

MODEL & CYLINDER HEIGHT	STANDARD 13-1/2" CYLINDER HEIGHT	CYLINDER HEIGHT OVER 13-1/2" (SPECIFY)
1870HM For hollow metal, 313, 335, or 628 finish, 1-1/4" backset	\$200	\$257

For cylinder height greater than 13-1/2" up to maximum cylinder height 65" please contact factory.

**How to Order** Specify quantity and the following information. Order related products separately.

PRODUCT NO.	FACEPLATE SHAPE	FINISH
187	0HM	-628
	0HM Flat	313 Dark Bronze Anodized
		335 Black Anodized
		628 Clear Anodized



## 1877 Cylinder-Operated Flushbolt

MODEL & CYLINDER HEIGHT	STANDARD 13-1/2" CYLINDER HEIGHT	CYLINDER HEIGHT OVER 13-1/2" (SPECIFY)
1877 For wood, 313 or 628 finish, 1-1/4" backset	\$242	\$299
1877 For wood, 626 finish, 1-1/4" backset	\$349	\$406

For cylinder height greater than 13-1/2" up to maximum cylinder height 57-1/2" please contact factory.

**How to Order** Specify quantity and the following information. Order related products separately.

PRODUCT NO.	FINISH
1877	-628
	313 Dark Bronze Anodized
	626 Satin Chrome
	628 Clear Anodized

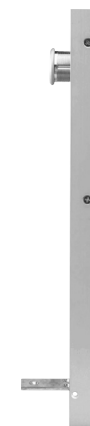

## MS1880, MS1881 Two-Point Flushbolts

MODELS & FINISHES		119, 121, 682
<b>MS1880</b>	Flushbolt with hourglass shaped turn	\$187
<b>MS1881</b>	Flushbolt with teardrop shaped turn	\$187
<b>KITTED OPTION</b>		
MODEL		
<b>TDK-1880</b>	Tall door kit for doors over 84", up to 144" maximum	\$36

**How to Order** Specify quantity and the following information. Order related products separately.

PRODUCT NO.	TURN SHAPE	CYLINDER HEIGHT*	FINISH
<b>MS188</b>	<b>0</b>	<b>-01</b>	<b>-682</b>
<b>MS188</b>	<b>0</b> Hourglass	<b>01</b> 31" to 35"	<b>119</b> to Match 335 Black Anodized
		<b>02</b> 35-1/16" to 39"	<b>121</b> to Match 313 Dark Bronze Anodized
	<b>1</b> Teardrop	<b>03</b> 39-1/16" 43"	<b>682</b> Satin Chrome
		<b>04</b> 43-1/16" to 47"	
		<b>05</b> 47-1/16" to 51"	

\*Distance from floor to cylinder centerline.



## MS2180 Auto-Release Two-Point Flushbolt

MODELS & FINISHES		119, 121, 130
<b>MS2180</b>	Hourglass shaped turn, 7', 8', 9', 10' door height	\$286
<b>MS2181</b>	Teardrop shaped turn, 7', 8', 9', 10' door height	\$286
<b>MS2182</b>	Flush operator, 7', 8', 9', 10' door height	\$286

**How to Order** Specify quantity and the following information. Order related products separately.

*PRODUCT NO.	TURN SHAPE	DOOR HEIGHT (FROM FLOOR TO TOP OF DOOR)	FINISH TO MATCH*
<b>MS218</b>	<b>0</b>	<b>-07</b>	<b>-130</b>
	<b>0</b> Hourglass	<b>07</b> Up to 7' Door	<b>119</b> to Match 335 Black Anodized
		<b>08</b> Up to 8' Door	<b>121</b> to Match 313 Dark Bronze Anodized
	<b>2</b> Flush Operator	<b>09</b> Up to 9' Door	<b>130</b> to Match 628 Clear Anodized
		<b>10</b> Up to 10' Door	

\*MS2182 only available in Electroless Nickel finish (-000)



## 4189, 4190 Flush Locksets (Including Deadlock)

MODELS & FINISHES	STANDARD LOCK FACE	STAINLESS STEEL LOCK FACE	TRIM ONLY
4189-IB Flush lockset, 119, 121, or 130 finish, individually boxed	\$124	\$136	
4190-IB Flush lockset, 119, 121, or 130 finish, individually boxed with cylinder	\$161	\$173	
4195-IB Dummy flushset, 119, 121, or 130 finish, individually boxed*			\$85
SPECIAL MODEL			
4189-00 Flush operator without lock			\$99
4190-00 Flush operator without lock			\$136

\*4195 Furnished without lock.



### Kitted Options

MODELS	GRAY
4413-01, 4413-02 Grip pull for use with 4189, 4190 includes 1" and 1-1/4" screws respectively	\$36

### How to Order Specify quantity and the following information. Order related products separately.

PRODUCT NO.	LOCKSET EXTERIOR	LOCK FACE	STILE THICKNESS	FINISH	KEYING OPTIONS	PACKAGING
41	90	-09	-1	-130	-01	IB
	89 Without Cylinder	00 Without Lock	1 1" to 1-3/8"	119 To match 335 Black Anodized	00 Without Cylinder	IB Individually Boxed
	90 With Cylinder	09 Radius	2 1-7/16" to 1-5/8"	121 To match 313 Dark Bronze Anodized	01 Keyed Different	
	95 Dummy	09S Radius Stainless Steel	3 1-11/16" to 2"	130 To match 628 Clear Anodized		
		10 Square				
		10S Square Stainless Steel				

## 4430, 4431 Flush Locksets (Including Deadlock)

MODELS & FINISH	STANDARD LOCK FACE	STAINLESS STEEL LOCK FACE	TRIM ONLY
4430-IB ABS flush lockset, individually boxed	\$86	\$99	
4431-IB ABS flush lockset with cylinder, individually boxed	\$129	\$143	
4432-IB ABS dummy flushset, individually boxed*			\$42
SPECIAL MODEL			
4430-00 ABS operator without lock			\$61
4431-00 ABS operator without lock			\$104

\*4432 Furnished without lock



### Kitted Options

MODELS & FINISHES	335
4453-02-335-IB Grip pull for use with 4430, 4431	\$94

### How to Order Specify quantity and the following information. Order related products separately.

PRODUCT NO.	LOCKSET EXTERIOR	LOCK FACE	STILE THICKNESS	PACKAGING
44	31	-09	-05	-IB
	30 Without Cylinder	00 Without Lock	00 1" to 1-5/16"	IB Individually Boxed
	31 With Cylinder	09 Radius	05 1-3/8" to 1-5/8"	
	32 Dummy	09S Radius Stainless Steel	08 1-3/4" to 2"	10PK 10 Pack
		10 Square		
		10S Square Stainless Steel		



# EXIT DEVICES

Alarm option cannot be combined with any other Device Option or Monitoring Option. Split finishes (faceplate/pushbar) are not available. Matching end cap option available for US finishes only. Please contact factory for specific ordering questions.

## 8099 Dummy Pushbar



MODELS & FINISHES	313, 335, 628	US4, US32D	US3, US32
<b>8099-M0</b> Active dummy bar without latching mechanism, without monitoring switches.	\$392	\$736	\$816
<b>8099-M1</b> Active dummy bar with monitoring switch but without latching mechanism. May be wired normally open or normally closed to operate maglock, alarm or similar.	\$464	\$808	\$888
<b>8099-M2</b> Active dummy bar with two monitoring switches but without latching mechanism. May be wired normally open or normally closed to operate maglock, alarm or similar.	\$546	\$890	\$970

**How to Order** Specify quantity and the following information. Order related products separately.

PRODUCT NO.	MONITOR	DOOR TYPE	PUSHBAR FINISH	WIDTH	US FINISH	END CAPS OPTION FOR US FINISH
8099	-M1	-3	0	36	-US32	MEC
	<b>M0</b> Active Dummy Bar, no monitoring switches	3 Aluminum	0 US Finish	30 30 inches	US3 Bright Brass	MEC Matching END Caps
	<b>M1</b> Active Dummy Bar, one monitoring switch	4 Wood or hollow metal	1 Clear Anodized 628	36 36 inches	US4 Satin Brass	
	<b>M2</b> Active Dummy Bar, two monitoring switches		2 Dark Bronze Anodized 313	42 42 inches	32 Bright Stainless	
			3 Black Anodized 335	48 48 inches	32D Satin Stainless	

## 8100 | 3100 Surface Vertical Rod Exit Device

MODELS & FINISHES	313, 335, 628	US4, US32D	US3, US32
<b>8100</b> Surface vertical rod exit device for wood and hollow metal	\$1,307	\$1,714	\$1,911
<b>8100T</b> Top rod only (less bottom rod) SVR exit device	\$1,208	\$1,615	\$1,812
<b>3100</b> Fire-rated surface vertical rod exit device for wood and hollow metal	\$1,558	\$1,965	\$2,162
<b>3100T</b> Fire-rated top rod only (less bottom rod) SVR for metal doors	\$1,459	\$1,866	\$2,063
<b>3100W</b> Fire-rated top rod only (less bottom rod) SVR for wood doors	\$1,459	\$1,866	\$2,063

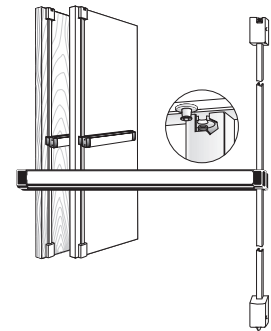

### Kitted Options

MODELS & FINISHES	313, 335, 628	US4, US32D	US3, US32
<b>3055</b> Tall door kit for doors up to 10' tall, for use with 3100	\$156	\$192	\$226
<b>8055-01</b> Tall door kit for doors up to 10' tall, for use with 8100, 8200	\$150	\$200	\$239

**How to Order** Specify quantity and the following information. Order related products separately.

MODEL	PUSHBAR FINISH	ROD TYPE	DEVICE OPTIONS	MONITORING OPTION	DOOR OPENING WIDTH ON PAIR OF DOORS, SPECIFY HALF OF THE TOTAL EXIT OPENING	US FINISH	END CAPS OPTION FOR US FINISH
81	00	-	MLR	M2	-30	-US32D	MEC
<b>31</b> Fire-Rated	00 US Finish	T Top Rod only	LR Electric Latch Retraction (solenoid)	M Single Switch	30 30 inches*	US3 Bright Brass	MEC Matching END Caps
<b>81</b> Life-Safety	11 Clear Anodized 628	W Top Rod only - Wood doors	MLR Motorized Latch Retraction	M2 Dual Switch	36 36 inches	US4 Satin Brass	
				(BLANK) NO Monitor	42 42 inches	US32 Bright Stainless	
	22 Dark Bronze Anodized 313	- Standard rod	C Cylinder Dogging (non-fire rated devices ONLY)	A Alarm	(BLANK) No Option	48 48 inches	
						AXXB Alarmed Exit Device where XX is door opening width	

\*Please note that 30" exit devices cannot accommodate monitoring options EXCEPT when ordered in conjunction with the MLR option.



US [adamsrite.com](http://adamsrite.com) | 800 872 3267 | [customerservice.adamsrite@assaabloy.com](mailto:customerservice.adamsrite@assaabloy.com)  
 CANADA [assaabloydss.ca](http://assaabloydss.ca) | 800 461 3007 | [sales.dss.ca@assaabloy.com](mailto:sales.dss.ca@assaabloy.com)

Patent pending and/or patent [www.assaabloydss.com/patents](http://www.assaabloydss.com/patents). Copyright © 2024, Hanchett Entry Systems, Inc., an ASSA ABLOY Group company. All rights reserved. Reproduction in whole or in part without the express written permission of Hanchett Entry Systems, Inc. is prohibited.

UPDATED April 18, 2024

## 8200 Narrow Stile Surface Vertical Rod Exit Device

MODELS & FINISHES	313, 335, 628	US4, US32D	US3, US32
8200 Narrow stile surface vertical rod exit device	\$1,107	\$1,513	\$1,729
8200T Top rod only (less bottom rod) SVR exit device	\$1,008	\$1,414	\$1,630
SPECIAL MODELS			
8200-99 SVR exit device, less rods	\$903	\$1,309	\$1,525

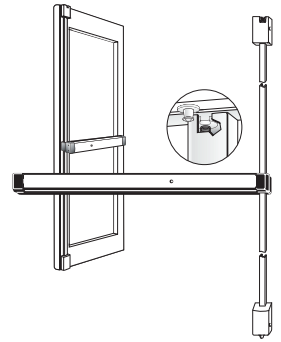

### Kitted Options

MODELS & FINISHES	313, 335, 628	US4, US32D	US3, US32
8055-01 Tall door kit for doors up to 10' tall, for use with 8100, 8200	\$150	\$200	\$239

**How to Order** Specify quantity and the following information. Order related products separately.

MODEL	PUSHBAR FINISH	ROD TYPE	DEVICE OPTIONS	MONITORING OPTION	DOOR OPENING WIDTH ON PAIR OF DOORS, SPECIFY HALF OF THE TOTAL EXIT OPENING	US FINISH	END CAPS OPTION FOR US FINISH
82	00	-	MLR	M2	-36	-US3	
82 Life-Safety	00 US Finish	T Top Rod only	LR Electric Latch Retraction (solenoid)	M Single Switch	30 30 inches	US3 Bright Brass	MEC Matching End Caps
	11 Clear Anodized 628	- Standard rod		M2 Dual Switch	36 36 inches	US4 Satin Brass	
	22 Dark Bronze Anodized 313		MLR Motorized Latch Retraction	(BLANK) NO Option	42 42 inches	US32 Bright Stainless	
	33 Black Anodized 335				48 48 inches	US32D Satin Stainless	
				C Cylinder Dogging			
			A Alarm				
			(BLANK) No Option				
					AXXB Alarmed Exit Device where XX is door opening width		

\* Please note that 30" exit devices cannot accommodate monitoring options EXCEPT when ordered in conjunction with the MLR option.

## 8300 | 3300 Mortise Exit Device

MODELS & FINISHES	313, 335, 628	US4, US32D	US3, US32
8300 Mortise exit device for wood and hollow metal	\$1,000	\$1,408	\$1,500
3300 Fire-rated mortise exit device for wood and hollow metal	\$1,275	\$1,683	\$1,775

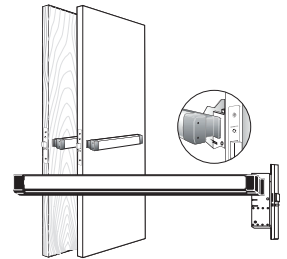

### Kitted Options

MODELS & FINISH	US32D	MODELS & FINISH	US32D
4009-01 Open back strike for 1-3/4" thick doors	\$174	91-0995-04-IP 2-1/2" thick door kit for use with 8300, 8400	\$27
91-0995-02-IP 2" thick door kit for use with 8300, 8400	\$23	91-0995-05-IP 2-3/4" thick door kit for use with 8300, 8400	\$32
91-0995-03-IP 2-1/4" thick door kit for use with 8300, 8400	\$23	91-0995-06-IP 3" thick door kit for use with 8300, 8400	\$32

For complete list of kitted options for mortise exit devices, please refer to 8400 Narrow Stile Mortise Exit Devices on next page.

**How to Order** Specify quantity and the following information. Order related products separately.

MODEL	FACEPLATE FINISH	FACE SHAPE	DEVICE OPTIONS	MONITORING OPTION	DOOR HANDING	PUSHBAR FINISH	DOOR OPENING WIDTH ON PAIR OF DOORS, SPECIFY HALF OF THE TOTAL EXIT OPENING	US FINISH	END CAPS OPTION FOR US FINISH
83	3	0	MLR	M	-7	3	A36B		
33 Fire-Rated	0 US Finish	0 Flat	LR Electric Latch Retraction (solenoid)	M Single Switch	7 RHR	0 US Finish	30 30 inches*	US3 Bright Brass	MEC Matching End Caps
	83 Life-Safety		1 Clear Anodized 628	M2 Dual Switch	8 LHR	1 Clear Anodized 628	36 36 inches	US4 Satin Brass	
			2 Dark Bronze Anodized 313	MLR Motorized Latch Retraction	(BLANK) No Monitor	2 Dark Bronze Anodized 313	42 42 inches	US32 Bright Stainless	
			3 Black Anodized 335	C Cylinder Dogging (non-fire rated devices ONLY)		3 Black Anodized 335	48 48 inches	US32D Satin Stainless	
				A Alarm			AXXB Alarmed Exit Device where XX is door opening width		
	- Without Options								

\* Please note that 30" exit devices cannot accommodate monitoring options EXCEPT when ordered in conjunction with the MLR option.

US adamsrite.com | 800 872 3267 | customerservice.adamsrite@assaabloy.com  
 CANADA assaabloydss.ca | 800 461 3007 | sales.dss.ca@assaabloy.com

Patent pending and/or patent www.assaabloydss.com/patents. Copyright © 2024, Hanchett Entry Systems, Inc., an ASSA ABLOY Group company. All rights reserved. Reproduction in whole or in part without the express written permission of Hanchett Entry Systems, Inc. is prohibited.

UPDATED April 18, 2024



## 8400 Narrow Stile Mortise Exit Device

MODEL & FINISHES	313, 335, 628	US4, US32D	US3, US32
8400 Narrow stile mortise exit device	\$825	\$1,225	\$1,359

Please contact factory for information on the 8475 Midpanel Mortise Exit Device. Pricing is standard pricing plus unique door cutting charge for custom cut length.

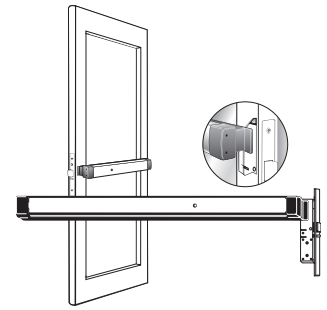

### Kitted Options

MODELS	US32D	MODELS	US32D
8455-01 Long face strike for covering MS strike prep	\$125	91-0995-04-IP 2-1/2" thick door kit for use with 8300, 8400	\$27
8460-17-630 Long lip strike for jambs that project outward 2-1/4" beyond the centerline of door	\$92	91-0995-05-IP 2-3/4" thick door kit for use with 8300, 8400	\$32
		91-0995-06-IP 3" thick door kit for use with 8300, 8400	\$32
91-0995-02-IP 2" thick door kit for use with 8300, 8400	\$23	91-0325-01 Thermal door kit, 1/4" cladding, for use with 8400	\$99
91-0995-03-IP 2-1/4" thick door kit for use with 8300, 8400	\$23	91-0325-02 Thermal door kit, 1/2" cladding, for use with 8400	\$178

### How to Order Specify quantity and the following information. Order related products separately.

MODEL	FACEPLATE FINISH	FACE SHAPE	DEVICE OPTIONS	MONITORING OPTION	BACKSET	DOOR HANDING	PUSHBAR FINISH	DOOR OPENING WIDTH ON PAIR OF DOORS, SPECIFY HALF OF THE TOTAL EXIT OPENING	US FINISH	END CAPS OPTION FOR US FINISH
84	1	4	MLR	M2	-4	7	1	42		
84 Life-Safety	0 US Finish	0 Flat, Radius, Bevel 4 Radius w/ Weatherstrip*	LR Electric Latch Retraction (solenoid) MLR Motorized Latch Retraction C Cylinder Dogging A Alarm - Without Options	M Switch	2 31/32"	7 RHR	0 US Finish	30 30 inches	US3 Bright Brass US4 Satin Brass US32 Bright Stainless US32D Satin Stainless	MEC Matching End Caps
	1 Clear Anodized 628			M2 Dual Switch	3 1-1/8"	8 LHR	1 Clear Anodized 628	36 36 inches		
	2 Dark Bronze Anodized 313			(BLANK) No Monitor	4 1-1/2"	2 Dark Bronze Anodized 313	42 42 inches	48 48 inches		
	3 Black Anodized 335					3 Black Anodized 335	AXXB Alarmed Exit Device where XX is door opening width			

\*Radius with weatherstrip faceplate is not available in US finishes.

## 8500 | 3600 Metal Door Concealed Vertical Rod Exit Device

MODELS & FINISHES	313, 335, 628	US4, US32D	US3, US32
8500 Concealed vertical rod exit device for hollow metal	\$925	\$1,328	\$1,462
8500T Top rod only (less bottom rod) CVR exit device	\$826	\$1,229	\$1,363
3600 Fire-rated concealed vertical rod exit device for hollow metal	\$1,420	\$1,823	\$1,957
3600T Fire-rated top rod only (less bottom rod) CVR exit device	\$1,321	\$1,724	\$1,858

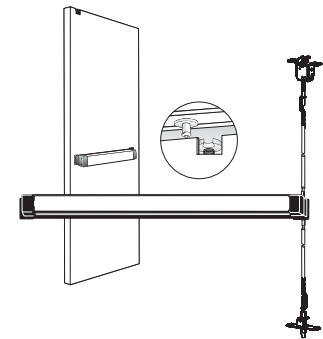

### Kitted Options

MODEL	PRICE
3655 Tall door kit for doors taller than 66" above bar height, up to 10'	\$73
8655 Tall door kit for doors taller than 66" above bar height, up to 10' for use with 8500, 8600	\$69

### How to Order Specify quantity and the following information. Order related products separately.

MODEL	PUSHBAR FINISH	ROD TYPE	DEVICE OPTIONS	MONITORING OPTION	DOOR OPENING WIDTH ON PAIR OF DOORS, SPECIFY HALF OF THE TOTAL EXIT OPENING	US FINISH	END CAPS OPTION FOR US FINISH
85	00	T	MLR	M	-36	-US32D	
36 Fire-Rated	00 US Finish	T Top Rod only	LR Electric Latch Retraction (solenoid) MLR Motorized Latch Retraction	M Single Switch	30 30 inches*	US3 Bright Brass US4 Satin Brass	MEC Matching End Caps
85 Life-Safety	11 Clear Anodized 628	- Standard rod		(BLANK) No Monitor	M2 Dual Switch		
	22 Dark Bronze Anodized 313				42 42 inches	US32 Bright Stainless US32D Satin Stainless	
	33 Black Anodized 335				48 48 inches		
			C Cylinder Dogging (non-fire rated devices only) A Alarm (BLANK) No Option		AXXB Alarmed Exit Device where XX is door opening width		

\* Please note that 30" exit devices cannot accommodate monitoring options EXCEPT when ordered in conjunction with the MLR option.



US [adamsrite.com](http://adamsrite.com) | 800 872 3267 | [customerservice.adamsrite@assaabloy.com](mailto:customerservice.adamsrite@assaabloy.com)  
 CANADA [assaabloydss.ca](http://assaabloydss.ca) | 800 461 3007 | [sales.dss.ca@assaabloy.com](mailto:sales.dss.ca@assaabloy.com)

Patent pending and/or patent [www.assaabloydss.com/patents](http://www.assaabloydss.com/patents). Copyright © 2024, Hanchett Entry Systems, Inc., an ASSA ABLOY Group company. All rights reserved. Reproduction in whole or in part without the express written permission of Hanchett Entry Systems, Inc. is prohibited.

UPDATED April 18, 2024

## 8600 Narrow Stile Concealed Vertical Rod Exit Device

MODELS & FINISHES	313, 335, 628	US4, US32D	US3, US32
8600 Narrow stile concealed vertical rod exit device	\$793	\$1,195	\$1,329
8600T Top rod only (less bottom rod) CVR exit device	\$694	\$1,096	\$1,230
SPECIAL MODELS			
8600-99 CVR exit device, less rods	\$695	\$1,097	\$1,231

Please contact factory for information on the 8675 Midpanel CVR Exit Device. Pricing is standard pricing plus unique door cutting charge for custom cut length.

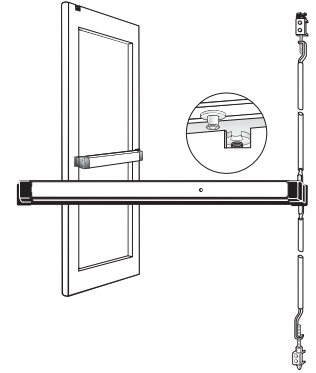

### Kitted Options

MODEL	PRICE
8655 Tall door kit for doors taller than 66" above bar height, up to 10' for use with 8500, 8600	\$69

### How to Order Specify quantity and the following information. Order related products separately.

MODEL	PUSHBAR FINISH	ROD TYPE	DEVICE OPTIONS	MONITORING OPTION	DOOR OPENING WIDTH ON PAIR OF DOORS, SPECIFY HALF OF THE TOTAL EXIT OPENING	US FINISH	END CAPS OPTION FOR US FINISH
86	22	T	MLR	M2	-36		
86 Life-Safety	00 US Finish	T Top Rod only	LR Electric Latch Retraction (solenoid)	M Single Switch	30 30 inches	US3 Bright Brass	MEC Matching End Caps
	11 Clear Anodized 628	- Standard rod		M2 Dual Switch	36 36 inches	US4 Satin Brass	
	22 Dark Bronze Anodized 313		MLR Motorized Latch Retraction	(BLANK) No Monitor	42 42 inches	US32 Bright Stainless	
			C Cylinder Dogging		48 48 inches		
	33 Black Anodized 335		A Alarm		AXXB Alarmed Exit Device where XX is door opening width	US32D Satin Stainless	
		(BLANK) No Option					

\*Please note that 30" exit devices cannot accommodate monitoring options EXCEPT when ordered in conjunction with the MLR option.

## 8700 | 3700 Starwheel Rim Exit Device

MODELS & FINISHES	313, 335, 628	US4, US32D	US3, US32
8700 Rim exit device for hollow metal and wood	\$766	\$1,139	\$1,247
3700 Fire-rated rim exit device for hollow metal and wood	\$966	\$1,339	\$1,447

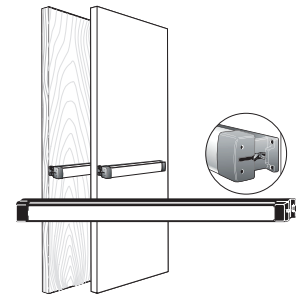

### Kitted Options

MODEL	PRICE
3889-08 Mullion for doors up to 8' for use with 8700, 3700	\$708

### How to Order Specify quantity and the following information. Order related products separately.

MODEL	PUSHBAR FINISH	DEVICE OPTIONS	MONITORING OPTION	DOOR OPENING WIDTH ON PAIR OF DOORS, SPECIFY HALF OF THE TOTAL EXIT OPENING	US FINISH	END CAPS OPTION FOR US FINISH	VOLTAGE**
87	00	EL	M2	-36	-US32		-12
37 Fire-Rated	00 US Finish	EL Electric Latch Retraction (solenoid)	M Single Switch	30 30 inches*	US3 Bright Brass	MEC Matching End Caps	12 Volts
87 Life-Safety	01 Clear Anodized 628		M2 Dual Switch	36 36 inches	US4 Satin Brass		24 Volts
	02 Dark Bronze Anodized 313	MLR Motorized Latch Retraction	(BLANK) No Monitor	42 42 inches	US32 Bright Stainless		
		C Cylinder Dogging (non-fire rated devices only)		48 48 inches			
	03 Black Anodized 335	A Alarm		AXXB Alarmed Exit Device where XX is door opening width	US32D Satin Stainless		
		(BLANK) No Option					

\*Please note that 30" exit devices cannot accommodate monitoring options EXCEPT when ordered in conjunction with the MLR option. \*\*EL Option Only.

## 8800 Narrow Stile Starwheel Rim Exit Device

MODEL & FINISHES	313, 335, 628	US4, US32D	US3, US32
8800 Narrow stile rim exit device	\$566	\$939	\$1,047



### Kitted Options

MODELS	313, 628
3890-08 Aluminum mullion for doors up to 8' for use with 8800	\$708
3890-10 Aluminum mullion for doors up to 10' for use with 8800	\$738



**How to Order** Specify quantity and the following information. Order related products separately.

MODEL	PUSHBAR FINISH	DEVICE OPTIONS	MONITORING OPTION	DOOR OPENING WIDTH ON PAIR OF DOORS, SPECIFY HALF OF THE TOTAL EXIT OPENING	US FINISH	END CAPS OPTION FOR US FINISH	VOLTAGE**
88	01	C	M2	-36			-12
88 Life-Safety	00 US Finish	EL Electric Latch Retraction (solenoid)	M Single Switch	30 30 inches	US3 Bright Brass	MEC Matching End Caps	12 Volts
	01 Clear Anodized 628			36 36 inches	US4 Satin Brass		24 Volts
	02 Dark Bronze Anodized 313	MLR Motorized Latch Retraction	(BLANK) No Monitor	42 42 inches	US32 Bright Stainless		
				48 48 inches			
	03 Black Anodized 335	C Cylinder Dogging (non-fire rated devices only)	(BLANK) No Option	AXXB Alarmed Exit Device where XX is door opening width			
A Alarm							

\*Please note that 30" exit devices cannot accommodate monitoring options EXCEPT when ordered in conjunction with the MLR option. \*\*EL Option Only.

## P8800 | P8700 Pullman Narrow Stile Rim Exit Device

MODEL & FINISHES	313, 335, 628	US4, US32D	US3, US32
P8800 Narrow stile rim exit device	\$556	\$929	\$1,037
P8700 Rim exit device for wood and hollow metal	\$725	\$1,098	\$1,206



### Kitted Options

MODELS	313, 628
3890-08 Aluminum mullion for doors up to 8' for use with P8800	\$708
3890-10 Aluminum mullion for doors up to 10' for use with P8800	\$738
3889-08 Mullion for doors up to 8' for use with P8700	\$708

**How to Order** Specify quantity and the following information. Order related products separately.

MODEL	PUSHBAR FINISH	DEVICE OPTIONS	MONITORING OPTION	DOOR OPENING WIDTH ON PAIR OF DOORS, SPECIFY HALF OF THE TOTAL EXIT OPENING	US FINISH	END CAPS OPTION FOR US FINISH
P88	01	C	M2	-36		
P88   P87	00 US Finish	MLR Motorized Latch Retraction	M Single Switch	30 30 inches	US3 Bright Brass	MEC Matching End Caps
	01 Clear Anodized 628	C Cylinder Dogging (non-fire rated devices only)		M2 Dual Switch	36 36 inches	
	02 Dark Bronze Anodized 313		A Alarm	(BLANK) No Monitor	42 42 inches	
		(BLANK) No Option			48 48 inches	
	03 Black Anodized 335			AXXB Alarmed Exit Device where XX is door opening width		

\*Please note that 30" exit devices cannot accommodate monitoring options EXCEPT when ordered in conjunction with the MLR option.

## 8900 | 3900 Wood Door Surface Concealed Vertical Rod Exit Device

MODELS & FINISHES	313, 335, 628	US4, US32D	US3, US32
8900 Surface concealed vertical rod exit device for wood	\$999	\$1,402	\$1,536
3900 Fire-rated surface concealed vertical rod for wood	\$1,480	\$1,883	\$2,017

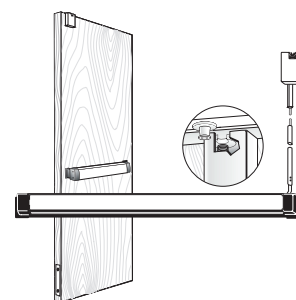

### Kitted Options

MODEL	PRICE
8955-01 Tall door kit for doors up to 10' for use with 8900	\$72
3955-01 Tall door kit for doors up to 10' for use with 3900	\$72

**How to Order** Specify quantity and the following information. Order related products separately.

MODEL	PUSHBAR FINISH	DEVICE OPTIONS	MONITORING OPTION	DOOR OPENING WIDTH ON PAIR OF DOORS, SPECIFY HALF OF THE TOTAL EXIT OPENING	US FINISH	END CAPS OPTION FOR US FINISH
89	00	LR	M2	-36	-US32	
39 Fire-Rated	00 US Finish	LR Electric Latch Retraction (solenoid)	M Single Switch	30 30 inches*	US3 Bright Brass	MEC Matching End Caps
89 Life-Safety	11 Clear Anodized 628		M2 Dual Switch	36 36 inches	US4 Satin Brass	
	22 Dark Bronze Anodized 313	MLR Motorized Latch Retraction	(BLANK) No Monitor	42 42 inches	US32 Bright Stainless	
	33 Black Anodized 335	C Cylinder Dogging (non-fire rated devices only)		48 48 inches	US32D Satin Stainless	
		A Alarm		AXXB Alarmed Exit Device where XX is door opening width		
		(BLANK) No Option				

\*Please note that 30" exit devices cannot accommodate monitoring options EXCEPT when ordered in conjunction with the MLR option.

## Accessories for 8000 | 3000 Series Exit Devices

OPTIONS & FINISHES	N/A
ALARM Battery-operated alarmed exit device. Alarm option cannot be combined with any other device option or monitoring options	\$582
C Cylinder dogging NOT available with electrified or fire-rated options	\$63
EL Electric latch retraction (solenoid) for use with 3700, 8700, 8800 Starwheel rim exit devices only	\$463
ELD Electric latch retraction (solenoid) with mechanical dogging for rim exit devices only	\$528
LR Electric latch retraction (solenoid) for use with CVR, Mortise and SVR exit devices	\$826

OPTIONS & FINISHES	N/A
MLR Motorized latch retraction	\$853
MEC Matching end caps. For US finishes only, not applicable to anodized finishes	\$104
M1 Monitor/single signal switch	\$161
M2 Monitor/dual signal switch	\$239

## Kitted Options for 8000 | 3000 Series Exit Devices

MODELS & FINISHES	N/A	313, 335, 628	US4, US32D	US3, US32	119, 121, 652
ALARM EXIT KIT Kit for retrofitting an alarm function to an existing Adams Rite exit device Includes new pushbar, end caps and installation hardware		\$754	\$1,040	\$1,116	
91-0897-01 Single signal switch kit, retrofits to 3000/8000	\$138				
91-0897-02 Dual signal switch kit, retrofits to 3000/8000	\$216				
26-0584-XXX-MP Sex bolts, 2 per bag, 2 kits required per exit device					\$35

## Modification Options for 8000 | 3000 Series Exit Devices

Please contact factory for all product modifications.

MODELS	ADD
THICK DOOR For doors thicker than 1-3/4" and/or door skins plus reinforcement thicker than those specified in the Adams Rite Master Reinforcement Sheet template, for CVR and Mortise Exit Devices	\$83
UNIQUE DOOR Cutting charges for non-standard custom cut lengths between 30" and 48"	\$108
CA California 5lb to unlatch done by exitmod only	\$108
INSULCLAD Modification specify cladding thickness to be 1/4"	\$100
INSULCLAD Modification specify cladding thickness to be 1/2"	\$181

Please note that thick door modification options are available for 8300, 8400, and 8600 series exit devices only.

US [adamsrite.com](http://adamsrite.com) | 800 872 3267 | [customerservice.adamsrite@assaabloy.com](mailto:customerservice.adamsrite@assaabloy.com)  
CANADA [assaabloydss.ca](http://assaabloydss.ca) | 800 461 3007 | [sales.dss.ca@assaabloy.com](mailto:sales.dss.ca@assaabloy.com)

Patent pending and/or patent [www.assaabloydss.com/patents](http://www.assaabloydss.com/patents). Copyright © 2024, Hanchett Entry Systems, Inc., an ASSA ABLOY Group company. All rights reserved. Reproduction in whole or in part without the express written permission of Hanchett Entry Systems, Inc. is prohibited.

UPDATED April 18, 2024



# ELECTRIC STRIKES

## 7100, 7101 Electric Strikes

MODELS & FINISHES	313, 335, 628	626
7100 For aluminum jambs	\$224	\$253
7101 For radius aluminum stiles	\$224	
7100-XX7, 7100-XX9 Monitoring signal switches	\$345	\$374

Lip Extensions up to 3" for center-hung or non-flush doors add \$42.



How to Order Specify quantity and the following information. Order related products separately.

PRODUCT NO.	FACEPLATE SHAPE	VOLTAGE	CURRENT AND DUTY	FEATURES*	FINISH**	LIP EXTENSIONS (DIM. A)*** (DOOR CENTERLINE TO JAMB EDGE)	
710	0	-3	1	0	-628	-00	
	0 Flat	3 12 Volt	1 DC Continuous or Intermittent	0 Standard/Fail-Secure	313 Dark Bronze Anodized	00 1-1/16" or less	05 2"
	1 Radius	4 16 Volt		5 Fail-Safe	335 Black Anodized	01 1-1/2"	07 2-1/4"
		5 24 Volt	4 AC Intermittent	7 Monitored/ Fail-Safe	626 Satin Chrome	02 1-5/8"	09 2-1/2"
				9 Monitored/ Fail-Secure	628 Clear Anodized	03 1-3/4"	12 2-7/8"

\*Fail-secure can be converted to fail-safe and vice versa. \*\*7101 available in 313, 335, 628 only \*\*\*Lip Extensions not available on 7101.

## 7110, 7111 Electric Strikes

MODELS & FINISHES	652
7110 For wood jambs	\$265
7111 For wood jambs, long faceplate	\$265
7110-XX7, 7110-XX9 Monitoring signal switches	\$386

Lip Extensions up to 3" for center-hung or non-flush doors add \$42.



How to Order Specify quantity and the following information. Order related products separately.

PRODUCT NO.	FACEPLATE LENGTH	VOLTAGE	CURRENT AND DUTY	FEATURES*	FINISH	LIP EXTENSIONS (DIM. A) (DOOR CENTERLINE TO JAMB EDGE)	
711	0	-3	1	0	-652	-00	
	0 7-15/16" 1 10-1/4"	3 12 Volt	1 DC Continuous or Intermittent	0 Standard/Fail-Secure	652 Satin Chrome	00 1-1/16" or less	05 2"
		4 16 Volt		5 Fail-Safe		01 1-1/2"	07 2-1/4"
		5 24 Volt	4 AC Intermittent	7 Monitored/ Fail-Safe		02 1-5/8"	09 2-1/2"
				9 Monitored/ Fail-Secure		03 1-3/4"	12 2-7/8"

\*Fail-secure can be converted to fail-safe and vice versa.



## 7130, 7131 Electric Strikes

MODELS & FINISHES	313, 335, 628
7130 For aluminum jambs, pre-cut for MS lock strike plate	\$224
7131 For radius aluminum stiles, pre-cut for MS lock strike plate	\$224
7130-XX7, 7130-XX9 Monitoring signal switch	\$345

Lip Extensions up to 3" for center-hung or non-flush doors add \$42.



How to Order Specify quantity and the following information. Order related products separately.

PRODUCT NO.	FACEPLATE SHAPE	VOLTAGE	CURRENT AND DUTY	FEATURES*	FINISH	LIP EXTENSIONS (DIM. A)** (DOOR CENTERLINE TO JAMB EDGE)	
713	0	-3	1	0	-313	-00	
	0 Flat	3 12 Volt	1 DC Continuous or Intermittent	0 Standard/Fail-Secure	313 Dark Bronze Anodized	00 1-1/16" or less	05 2"
	1 Radius	4 16 Volt	4 AC Intermittent	5 Fail-Safe	335 Black Anodized	01 1-1/2"	07 2-1/4"
		5 24 Volt		7 Monitored/ Fail-Safe	628 Clear Anodized	02 1-5/8"	09 2-1/2"
				9 Monitored/ Fail-Secure		03 1-3/4"	12 2-7/8"

\*Fail-secure can be converted to fail-safe and vice versa. \*\*Lip extensions not available on 7131.

## 7140 Electric Strike

MODEL & FINISHES	313, 335, 628	626
7140 ANSI size for hollow metal and wood jambs	\$224	\$253
7140-XX7, 7140-XX9 Monitoring signal switch	\$345	\$374

Lip Extensions up to 3" for center-hung or non-flush doors add \$42.



How to Order Specify quantity and the following information. Order related products separately.

PRODUCT NO.	VOLTAGE	CURRENT AND DUTY	FEATURES*	FINISH	LIP EXTENSIONS (DIM. A) (DOOR CENTERLINE TO JAMB EDGE)	
7140	-3	1	0	-628	-00	
	3 12 Volt	1 DC Continuous or Intermittent	0 Standard/ Fail-Secure	313 Dark Bronze Anodized	00 1-1/16" or less	05 2"
	4 16 Volt	4 AC Intermittent	5 Fail-Safe	335 Black Anodized	50 1-3/8"	07 2-1/4"
	5 24 Volt		7 Monitor/Fail-Safe	626 Satin Chrome	01 1-1/2"	09 2-1/2"
			9 Monitor/Fail-Secure	628 Clear Anodized	02 1-5/8"	12 2-7/8"
					03 1-3/4"	

\*Fail-secure can be converted to fail-safe and vice versa.

## 7160 Electric Strike

MODELS & FINISHES	313, 335, 628	626
7160 For aluminum jambs	\$284	\$314
7160-XX7, 7160-XX9 Monitoring signal switches	\$403	\$474

Lip Extensions up to 3" for center-hung or non-flush doors add \$42.



How to Order Specify quantity and the following information. Order related products separately.

PRODUCT NO.	VOLTAGE	CURRENT AND DUTY	FEATURES*	FINISH	LIP EXTENSIONS (DIM. A) (DOOR CENTERLINE TO JAMB EDGE)	
7160	-3	1	0	-628	-00	
	3 12 Volt	1 DC Continuous or Intermittent	0 Standard/Fail-Secure	313 Dark Bronze Anodized	00 1-1/16" or less	05 2"
	4 16 Volt	4 AC Intermittent	5 Fail-Safe	335 Black Anodized	01 1-1/2"	07 2-1/4"
	5 24 Volt		7 Monitor/Fail-Safe	626 Satin Chrome	02 1-5/8"	09 2-1/2"
			9 Monitor/Fail-Secure	628 Clear Anodized	03 1-3/4"	12 2-7/8"

\*Fail-secure can be converted to fail-safe and vice versa.

US adamsrite.com | 800 872 3267 | customerservice.adamsrite@assaabloy.com  
CANADA assaabloydss.ca | 800 461 3007 | sales.dss.ca@assaabloy.com

Patent pending and/or patent www.assaabloydss.com/patents. Copyright © 2024, Hanchett Entry Systems, Inc., an ASSA ABLOY Group company. All rights reserved. Reproduction in whole or in part without the express written permission of Hanchett Entry Systems, Inc. is prohibited.

UPDATED April 15, 2024

Adams  
Rite  
ASSA ABLOY

## 7170 Electric Strike

MODELS & FINISHES	313, 335, 628	626
7170 For hollow metal and wood jambs	\$284	\$314
7170-XX7, 7170-XX9 Monitoring signal switches	\$403	\$474

Lip Extensions up to 3" for center-hung or non-flush doors add \$42.



How to Order Specify quantity and the following information. Order related products separately.

PRODUCT NO.	VOLTAGE	CURRENT AND DUTY	FEATURES*	FINISH	LIP EXTENSIONS (DIM. A) DOOR CENTERLINE TO JAMB EDGE	
7170	-3	1	0	-628	-00	
	3 12 Volt	1 DC Continuous or Intermittent	0 Standard/Fail-Secure	313 Dark Bronze Anodized	00 1-1/16" or less	05 2"
	4 16 Volt		5 Fail-Safe	335 Black Anodized	50 1-3/8"	07 2-1/4"
	5 24 Volt	4 AC Intermittent	7 Monitor/Fail-Safe	626 Satin Chrome	01 1-1/2"	09 2-1/2"
			9 Monitor/Fail-Secure	628 Clear Anodized	02 1-5/8"	12 2-7/8"
					03 1-3/4"	

\*Fail-secure can be converted to fail-safe and vice versa.

## 7100 Series Electric Strike Components

STRIKE BODY KITS	PRICE
7103A For use with 7100/7101, 7110/7111, 7130/7131, 7140	\$187
7173A For use with 7160, 7170	\$241

One strike body kit matched with one faceplate kit makes a complete electric strike assembly.

FACEPLATE KITS & FINISHES	313, 335, 628	626	605
FPK00 For use with body kits: 7103A, 7173A	\$37	\$67	\$74
FPK01 For use with body kit: 7103A	\$38		
FACEPLATE KITS & FINISHES			652
FPK10 For use with body kit: 7103A			\$78
FPK11 For use with body kits: 7103A			\$78
FACEPLATE KITS & FINISHES	313, 335, 628	626	605
FPK30 For use with body kit: 7103A	\$43		
FPK31 For use with body kits: 7103A	\$43		
FPK40 For use with body kit: 7103A, 7173A	\$37	\$67	\$75
FPK45 For use with body kit: 7103A, for installing electric strike in previous prep, 4901, 4501 strike cover.	\$43		

Faceplate kits contain all hardware to mount electric strike.

## Kitted Options

MODELS	PRICE
91-0171-01 THROUGH -13 Lip extension kits for use with 7100 through 7140	\$42
91-0171-50 Lip extension kits for use with 7100 through 7140 interior framing systems	\$42
91-0172-01 THROUGH -13 Lip extension kits for use with 7160 and 7170	\$42
91-0172-50 Lip extension kits for use with 7160 and 7170 interior framing systems	\$41

## How to Order

Specify quantity and the following information. Order related products separately.

PRODUCT NO.	VOLTAGE	CURRENT AND DUTY	FEATURES*
7103A	3	1	0
7103A	3 12 Volt	1 DC Continuous or Intermittent	0 Standard/Fail-Secure
7173A	4 16 Volt		
	5 24 Volt		

\*Fail-secure can be field converted to fail-safe or vice versa.

## 7240 Fire-Rated Electric Strike

MODELS & FINISH	630
7240 Fire-rated, for cylindrical latches	\$459
7240-50 Lip extension for interior frame systems	\$504
7240-XX9 Monitoring signal switches	\$591



How to Order Specify quantity and the following information. Order related products separately.

PRODUCT NO.	VOLTAGE	CURRENT AND DUTY	FEATURES*	FINISH	LIP EXTENSIONS (DIM. A) DOOR CENTERLINE TO JAM EDGE FOR INTERIOR FRAMES
7240	-3	1	0	-630	-50
	3 12 Volt	1 DC Continuous or Intermittent	0 Fail-Secure	630 Satin Stainless	00 1-1/16" or less
	5 24 Volt	4 AC Intermittent	9 Monitor/Fail-Secure		50 1-3/8"

\*Not available in fail-safe.

## 7270 Fire-Rated Electric Strike

MODELS & FINISH	630
7270 Fire-rated, for mortise latches	\$533
7270-50 Lip extension for interior frame systems	\$576
7270-XX9 Monitoring signal switches	\$663



How to Order Specify quantity and the following information. Order related products separately.

PRODUCT NO.	VOLTAGE	CURRENT AND DUTY	FEATURES*	FINISH	LIP EXTENSIONS (DIM. A) DOOR CENTERLINE TO JAM EDGE FOR INTERIOR FRAMES
7270	-3	1	0	-630	-50
	3 12 Volt	1 DC Continuous or Intermittent	0 Fail-Secure	630 Satin Stainless	00 1-1/16" or less
	5 24 Volt	4 AC Intermittent	9 Monitor/Fail-Secure		50 1-3/8"

\*Not available in fail-safe.

## 7400, 7401 UltraLine® Preload-Capable Electric Strikes

MODELS & FINISHES	313, 335, 628	630	605, 606, 629	119, 121, 130
7400 For radius jambs	\$305	\$344	\$355	
7400M Monitoring signal switches	\$425	\$457	\$478	
7401 For radius aluminum stiles				\$305
7401M Monitoring signal switches				\$433

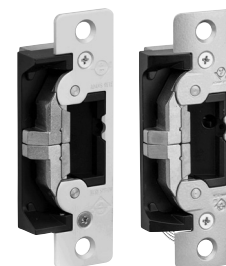

How to Order Specify quantity and the following information. Order related products separately.

PRODUCT NO.	FACEPLATE SHAPE	FEATURES	FINISH		
740	0	M	628		
	0 Flat	- None	7400 ONLY		7401 ONLY
	1 Radius	M Monitored	313 Dark Bronze Anodized	628 Clear Anodized	119 To match 335 Black Anodized
		A Modular Pack - Body Kit*	335 Black Anodized	629 Bright Stainless	121 To match 313 Dark Bronze Anodized
			605 Bright Brass	630 Satin Stainless	130 To match 628 Clear Anodized
			606 Satin Brass		

Fail-secure can be converted to fail-safe and vice versa. \* See page 25 for body or faceplate options.

US [adamsrite.com](http://adamsrite.com) | 800 872 3267 | [customerservice.adamsrite@assaabloy.com](mailto:customerservice.adamsrite@assaabloy.com)  
CANADA [assaabloydss.ca](http://assaabloydss.ca) | 800 461 3007 | [sales.dss.ca@assaabloy.com](mailto:sales.dss.ca@assaabloy.com)

Patent pending and/or patent [www.assaabloydss.com/patents](http://www.assaabloydss.com/patents). Copyright © 2024, Hanchett Entry Systems, Inc., an ASSA ABLOY Group company. All rights reserved. Reproduction in whole or in part without the express written permission of Hanchett Entry Systems, Inc. is prohibited.

UPDATED April 15, 2024

 Adams  
Rite  
**ASSA ABLOY**

## 7410, 7411 UltraLine® Preload-Capable Electric Strikes

MODELS & FINISHES	313, 335, 628	630
7410 For wood jambs, 7-15/16" faceplate	\$344	\$374
7410M Monitoring signal switches	\$472	\$495
7411 For wood jambs, 10-1/4" faceplate, not available in 335 Finish	\$350	\$381
7411M Monitoring signal switches		\$495



How to Order Specify quantity and the following information. Order related products separately.

PRODUCT NO.	FACEPLATE LENGTH	FEATURES	FINISH	
741	0	-	628	
	0 7-15/16"	- None	313 Dark Bronze Anodized	628 Clear Anodized
	1 10-1/4"	M Monitored	335 Black Anodized	630 Satin Stainless

*Fail-secure can be converted to fail-safe and vice versa.*

## 7430, 7431 UltraLine® Preload-Capable Electric Strikes

MODELS & FINISHES	313, 335, 628	119, 121, 130
7430 For aluminum jambs, flat faceplate	\$313	
7430M Monitoring signal switches	\$439	
7431 For aluminum stiles, radius faceplate		\$313
7431M Monitoring signal switches, not available in 119 finish.		\$439



How to Order Specify quantity and the following information. Order related products separately.

PRODUCT NO.	FACEPLATE SHAPE	FEATURES	FINISH	
743	0	M	628	
	0 Flat	- None	313 Dark Bronze Anodized	119 To match 335 Black Anodized
	1 Radius	M Monitored	335 Black Anodized	121 To match 313 Dark Bronze Anodized
			628 Clear Anodized	130 To match 628 Clear Anodized

*Fail-secure can be converted to fail-safe and vice versa.*

## 7440 UltraLine® Preload-Capable Electric Strike

MODELS & FINISHES	313, 335, 628	630	605, 606, 629
7440 For hollow metal and wood, jambs and doors	\$305	\$344	\$355
7440M Monitoring signal switches	\$425	\$457	\$478

*Fail-secure can be converted to fail-safe and vice versa.*

How to Order Specify quantity and the following information. Order related products separately.

PRODUCT NO.	FEATURES	FINISH		
7440	M	628		
	- None	313 Dark Bronze Anodized	606 Satin Brass	629 Bright Stainless
	M Monitored	335 Black Anodized	628 Clear Anodized	630 Satin Stainless
		605 Bright Brass		

*Fail-secure can be converted to fail-safe and vice versa.*



## 74R1 UltraLine® Preload-Capable Electric Strike

MODELS & FINISHES	119, 121, 130
<b>74R1</b> For use with rim exit devices with 3/4" latchbolt	\$427
<b>74R1M</b> Monitoring signal switches	\$550

**How to Order** Specify quantity and the following information. Order related products separately.

PRODUCT NO.	FEATURES	FINISH
74R1	M	-130
	- None	119 To match 335 Black Anodized
	M Monitored	121 To match 313 Dark Bronze Anodized
		130 To match 628 Clear Anodized

*Fail-secure can be converted to fail-safe and vice versa.*



## 74R2 UltraLine® Preload-Capable Electric Strike

MODELS & FINISHES	119, 121, 130
<b>74R2</b> For use with narrow stile rim exit devices with 1/2" latchbolt	\$427

**How to Order** Specify quantity and the following information. Order related products separately.

PRODUCT NO.	FINISH
74R2	-130
	119 To match 335 Black Anodized
	121 To match 313 Dark Bronze Anodized
	130 To match 628 Clear Anodized

*Fail-secure can be field converted to fail-safe or vice-versa.*



**MODULAR PACKING PROGRAM** — match strike body kit with faceplate kit for complete electric strike.  
Select 7400A for standard jambs and 7401A for radius stile mounting. No finish designation required for strike body kits.

## 7400 UltraLine® Electric Strike Components

STRIKE BODY KITS	PRICE
<b>7400A</b> Standard body, for use in single door applications	\$282
<b>7401A</b> Radius body, for use in applications with pairs of doors	\$282

*Match one strike body kit with one faceplate kit to make a complete electric strike assembly.*

FACEPLATE KITS & FINISHES	313, 335, 628	630	605, 606, 629	119, 121, 130
<b>FPK7400</b> For use with body kit: 7400A	\$31	\$62	\$74	
<b>FPK7401</b> For use with body kit: 7401A				\$31
<b>FPK7410</b> For use with body kit: 7400A	\$69	\$96		
<b>FPK7411</b> For use with body kit: 7400A, not available in 335 finish	\$74	\$102		
<b>FPK7430</b> For use with body kit: 7400A	\$36			
<b>FPK7431</b> For use with body kit: 7401A				\$36
<b>FPK7440</b> For use with body kit: 7400A	\$31	\$62	\$74	
<b>FPK7445</b> For use with body kit: 7400A, not available in 335 finish. For installing electric strike in previous prep 4901, 4501, strike cover.	\$43			

*Faceplate kits contain all hardware to mount electric strike.*

US [adamsrite.com](http://adamsrite.com) | 800 872 3267 | [customerservice.adamsrite@assaabloy.com](mailto:customerservice.adamsrite@assaabloy.com)  
CANADA [assaabloydss.ca](http://assaabloydss.ca) | 800 461 3007 | [sales.dss.ca@assaabloy.com](mailto:sales.dss.ca@assaabloy.com)

Patent pending and/or patent [www.assaabloydss.com/patents](http://www.assaabloydss.com/patents). Copyright © 2024, Hanchett Entry Systems, Inc., an ASSA ABLOY Group company. All rights reserved. Reproduction in whole or in part without the express written permission of Hanchett Entry Systems, Inc. is prohibited.

UPDATED April 15, 2024



## Kitted Options

MODELS	PRICES
LEK7400 Lip extension kits for use with 7400 series electric strikes, for flat faceplates only	\$55
VA7400-12 12 VDC adapter cable for 7400 electric strikes	\$16
VA7400-16VDC 16 VDC adapter kit for 7400 electric strikes	\$26
VA7400-24 24 VDC adapter cable for 7400 electric strikes	\$16
WDC7400 Wood door cover plate for use when mounting 7400 in the inactive leaf of a wood door pair (to simplify the mortising operation)	\$16
ELX ElectroLynx™ Adapter to connect Adams Rite products to the ElectroLynx system	\$39

How to Order Specify quantity and the following information. Order related products separately.

PRODUCT NO.	LIP EXTENSIONS (DISTANCE FROM VERTICAL CENTERLINE OF THE DOOR IN THE CLOSED POSITION TO THE EDGE OF THE JAMB)							
LEK7400	-00							
	01 1-1/2"	03 1-3/4"	05 2"	07 2-1/4"	09 2-1/2"	11 2-3/4"	13 3"	
	02 1-5/8"	04 1-7/8"	06 2-1/8"	08 2-3/8"	10 2-5/8"	12 2-7/8"	50 1-3/8"	

## 7800 Series Electric Strike

MODELS	630	613E, 628E, BSP	606	605, 629
7800 For use with Starwheel and Interlocking rim exit devices.	\$709	\$786	\$832	\$846

## Accessories

MODELS	630	613E	628E	BSP	N/A
7800-116-XXX 1/16" Spacer plate	\$39	\$54	\$54	\$53	
7800-108-XXX 1/8" Spacer plate	\$39	\$54	\$53	\$53	
7800-SMB HES Surface Mounting Box					\$244

## How to Order

Specify quantity and the following information.  
Order related products separately.

PRODUCT NO.	FINISH
7800	— 630
	605 Bright Brass
	606 Satin Brass
	613E Dark Oxidized Satin Bronze Powder
	628E Satin Aluminum Clear Anodized
	629 Bright Stainless
	630 Satin Stainless
	BSP Black Suede Powder

\*Fail-secure can be field converted to fail-safe and vice versa.







# TRIM

## 1000 Series Turns

MODELS & FINISHES	119, 121, 130
1000-01, 1000-02 Turn for use with MS1847 deadlock	\$34
1000-11, 1000-21 Stainless steel turn and escutcheon for use with MS1847 deadlock	\$42
1004 Turn for use with 5015, 5017 deadlock	\$42
1015 Turn for use with 5015, 5017 deadlock	\$42
1016 Outside escutcheon	\$34



How to Order Specify quantity and the following information. Order related products separately.

PRODUCT NO.	TURN TYPE	SPINDLE LENGTH	FINISH																																																																								
1000	-21	-14	-130																																																																								
	<b>TURN WITHOUT ESCUTCHEON</b> FURNISHED Unassembled  <b>-01</b> PARALLEL Drive  <b>-02</b> PERPENDICULAR Drive	<b>DASH CHART</b> <table border="1"> <thead> <tr> <th>NO.</th> <th>"L"</th> <th>MM</th> <th>NO.</th> <th>"L"</th> <th>MM</th> </tr> </thead> <tbody> <tr><td>-11</td><td>17/32</td><td>13</td><td>-22</td><td>1-15/64</td><td>31</td></tr> <tr><td>-12</td><td>39/64</td><td>15</td><td>-23</td><td>1-19/64</td><td>33</td></tr> <tr><td>-13</td><td>43/64</td><td>17</td><td>-24</td><td>1-23/64</td><td>35</td></tr> <tr><td>-14</td><td>47/64</td><td>19</td><td>-25</td><td>1-27/64</td><td>36</td></tr> <tr><td>-15</td><td>51/64</td><td>20</td><td>-26</td><td>1-31/64</td><td>38</td></tr> <tr><td>-16</td><td>55/64</td><td>22</td><td>-27</td><td>1-33/64</td><td>39</td></tr> <tr><td>-17</td><td>59/64</td><td>23</td><td>-28</td><td>1-39/64</td><td>41</td></tr> <tr><td>-18</td><td>63/64</td><td>25</td><td>-29</td><td>1-43/64</td><td>42</td></tr> <tr><td>-19</td><td>1-3/64</td><td>26</td><td>-30</td><td>1-47/64</td><td>44</td></tr> <tr><td>-20</td><td>1-7/64</td><td>28</td><td>-31</td><td>1-51/64</td><td>46</td></tr> <tr><td>-21</td><td>1-11/64</td><td>30</td><td>-32</td><td>1-55/64</td><td>47</td></tr> </tbody> </table>	NO.	"L"	MM	NO.	"L"	MM	-11	17/32	13	-22	1-15/64	31	-12	39/64	15	-23	1-19/64	33	-13	43/64	17	-24	1-23/64	35	-14	47/64	19	-25	1-27/64	36	-15	51/64	20	-26	1-31/64	38	-16	55/64	22	-27	1-33/64	39	-17	59/64	23	-28	1-39/64	41	-18	63/64	25	-29	1-43/64	42	-19	1-3/64	26	-30	1-47/64	44	-20	1-7/64	28	-31	1-51/64	46	-21	1-11/64	30	-32	1-55/64	47	119 To match 335 Black Anodized 121 To match 313 Dark Bronze Anodized 130 To match 628 Clear Anodized
NO.	"L"	MM	NO.	"L"	MM																																																																						
-11	17/32	13	-22	1-15/64	31																																																																						
-12	39/64	15	-23	1-19/64	33																																																																						
-13	43/64	17	-24	1-23/64	35																																																																						
-14	47/64	19	-25	1-27/64	36																																																																						
-15	51/64	20	-26	1-31/64	38																																																																						
-16	55/64	22	-27	1-33/64	39																																																																						
-17	59/64	23	-28	1-39/64	41																																																																						
-18	63/64	25	-29	1-43/64	42																																																																						
-19	1-3/64	26	-30	1-47/64	44																																																																						
-20	1-7/64	28	-31	1-51/64	46																																																																						
-21	1-11/64	30	-32	1-55/64	47																																																																						
	<b>TURN WITH ESCUTCHEON</b> FURNISHED Assembled  <b>-11</b> PARALLEL Drive  <b>-21*</b> PERPENDICULAR Drive																																																																										

\*-21 option not available for 1015 and 1016 turns

## 3000 Fixed Pull

MODELS & FINISH	US32D
3001 Tubular fixed pull for hollow metal or wood doors	\$243
3002 Flat fixed pull for hollow metal or wood doors	\$269

### How to Order

Specify quantity and the following information. Order related products separately.

PRODUCT NO.	HANDLE	CYLINDER HOLE	EXIT DEVICE	FINISH
300	1	-1	1	-US32D
	1 Round	1 Without Hole	1 Mortise, Rim	US32D Satin Stainless
	2 Flat	2 With Hole	2 CVR	
			3 SVR	

Not for use with the following narrow stile exit devices: 8200 SVR, 8400 Mortise, 8600 CVR, 8800 Rim Exit Devices.



## 3080 Series Entry Trim

MODELS & FINISHES		STANDARD TRIM		ELECTRIFIED TRIM	
		US4, US32D, 10B	US3, US32	US4, US32D, 10B	US3, US32
STANDARD LEVER	3080 Entry trim with standard lever (01, 02, 03)	\$427	\$474	\$826	\$873
	3080-M Entry trim with standard lever (01, 02, 03) with matching trim cover finish	\$538	\$585	\$937	\$984
	3080-U Entry trim with standard lever (01, 02, 03) with universal trim kit includes tailpieces and trimplates for use with all Adams Rite exit devices	\$458	\$505	\$857	\$904
	3080-U, M Entry trim with standard lever (01, 02, 03), matching trim cover and universal trim kit	\$569	\$616	\$968	\$1,015
DESIGNER LEVER	3080-MX Entry trim with designer lever series (MD through MW)	\$484	\$531	\$883	\$930
	3080-MX, M Entry trim with designer lever series (MD through MW) with matching trim cover	\$595	\$642	\$994	\$1,041
	3080-MX, U Entry trim with designer lever series (MD through MW) with universal trim kit	\$515	\$562	\$914	\$961
	3080-MX, U, M Entry trim with designer lever series (MD through MW), universal trim kit and matching trim cover	\$626	\$673	\$1,025	\$1,072



Tactile strip now available as a Kitted Option (below) for standard levers 01 and 03.

### Kitted Options

MODELS	PRICE
91-0686 Adaptor kit for 3080 trim and G86 exit device	\$37
91-0118 Tactile strip for 3080 standard levers 01, 03	\$46

How to Order Specify quantity and the following information. Order related products separately.

PRODUCT NO.	ELECTRIFIED	HANDLE	HANDING	CYLINDER HOLE	EXIT DEVICE	VOLTAGE	FEATURES	TRIM COVER FINISH	FINISH		
3080	E	-01	-0	-3	7	-3	0	M	US32D		
	(BLANK) Standard	STANDARD Handles	0 No Handing	3 With Hole	1 SVR	ELECTRIFIED Trim Only	ELECTRIFIED Trim Only	- Standard (Black)	US3 Bright Brass		
	E Electrified Trim	01 Curve	7 RHR*	9 Without Hole	3 Mortise	3 12 Volt DC	0 Fail-Secure	M Matching Finish	US4 Satin Brass		
		02 Round			4 SCVR				5 24 Volt DC	5 Fail-Safe	10B Dark Bronze
		03 Square			6 CVR						US32 Bright Stainless
		DESIGNER Series			7 Rim					US32D Satin Stainless	
		MD MJ			U Universal Kit						
		ME MN* (Handed)									
		MG MV* (Handed)									
		MI MW									

\* Handing must be specified for MN and MV Designer Levers.

## 3090 eForce® Keyless Entry

MODELS & FINISHES	FOR DEADLATCHES & EXITS	FOR DEADLOCKS
	626, 121	626, 121
3090-01, 3090-02 eForce keyless entry with keypad	3090-01	3090-02
	\$940	\$967

### Kitted Options

MODELS	PRICE
RSK-3090 Remote switch input connector	\$23

How to Order Specify quantity and the following information. Order related products separately.

PRODUCT NO.	COMPATIBLE PRODUCTS	FINISH
3090	-01	-626
	01 Adams Rite latches or 8000 Series Exit Devices	121 To match 313 Dark Bronze Anodized
	02 Adams Rite MS® deadlocks	626 Satin Chrome



## 4060 Turn

MODEL & FINISH	PRICE
4060 Turn for 1875 deadlock, 1-1/2", 1-3/4", or 2" door thickness	\$99

How to Order Specify quantity and the following information. Order related products separately.

PRODUCT NO.	DOOR THICKNESS	FINISH
4060	-05	-130
	05 1-1/2"	130 To match 628 Clear Anodized
	06 1-3/4"	
	07 2"	

Please contact factory regarding mounting spacers, bolts, guides and strikes for particular door designs.

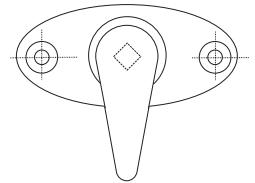

## 4550 MS® Deadlock Lever

MODEL & FINISHES	PRICE
4550, 01 Deadlock lever, 1-3/4" to 2" door thickness	\$238
4550, 02 Deadlock lever, 2-1/8" to 2-3/8" door thickness	\$287

How to Order Specify quantity and the following information. Order related products separately.

PRODUCT NO.	DOOR HAND	DOOR THICKNESS	FINISH
4550	R	-01	-130
	R RH or RHR	01 1-3/4" to 2"	119 To match 335 Black Anodized
	L LH or LHR	02 2-1/8" to 2-3/8"	121 To match 313 Dark Bronze Anodized
			130 To match 628 Clear Anodized



## 4560, 4565 Series Deadlatch Handles for 4300, 4500, 4900 Deadlatches

MODELS & FINISHES	119, 121, 130
4560-X01 For door thickness (01) 1-3/4" to 2"	\$64
4560-X02 For door thickness (02) 2-1/4" to 2-1/2"	\$89
4560-X03 For door thickness (03) 2-3/4" to 3"	\$89
4560-X04 For door thickness (04) 3-1/4"	\$89
4565-X01 For door thickness (01) 1-3/4" to 2"	\$69
4565-X02 For door thickness (02) 2-1/4" to 2-1/2"	\$96
4565-X03 For door thickness (03) 2-3/4" to 3"	\$96
4565-X04 For door thickness (04) 3-1/4"	\$96



## 4560-010, 4565-010 Series Deadlatch Handles for MS+1890 Deadlock/Deadlatch

MODELS & FINISHES	119, 121, 130
4560-011 For door thickness (11) 1-3/4"	\$47
4560-012 For door thickness (12) 1-3/4" to 2-1/4"	\$58
4560-013 For door thickness (13) 2-15/16" to 2-3/4"	\$58
4565-011 For door thickness (11) 1-3/4"	\$51
4565-012 For door thickness (12) 1-3/4" to 2-1/4"	\$63

How to Order Specify quantity and the following information. Order related products separately.

PRODUCT NO.	HANDLE TYPE	HANDING	DOOR THICKNESS		FINISH
456	0	-5	01		-130
	0 Lever	0 Using MS+1890	FOR 4300, 4500, 4900 Series Deadlatches	FOR MS+1890	119 To match 335 Black Anodized
	5 Turn	5 LH or LHR			121 To match 313 Dark Bronze Anodized
		6 RH or RHR	01 1-3/4" to 2"	11 1-3/4"	130 To match 628 Clear Anodized
			02 2-1/4" to 2-1/2"	12 1-3/4" to 2-1/4"	
			03 2-3/4" to 3"	13 2-5/16" to 2-3/4"	
			04 3-1/4"		

## 4568, 4569 Eurostyle Deadlatch Handles for 4300, 4500, 4900 Deadlatches

MODELS & FINISHES	119, 121, 130
4568-X01 For door thickness (01) 1-3/4" to 2"	\$77
4568-X02 For door thickness (02) 2-1/4" to 2-1/2"	\$98
4568-X03 For door thickness (03) 2-3/4" to 3"	\$98
4568-X04 For door thickness (04) 3-1/4"	\$98
4569-X01 For door thickness (01) 1-3/4" to 2"	\$89
4569-X02 For door thickness (02) 2-1/4" to 2-1/2"	\$105
4569-X03 For door thickness (03) 2-3/4" to 3"	\$106
4569-X04 For door thickness (04) 3-1/4"	\$106



## 4568-010, 4569-010 Series Deadlatch Handles for MS+1890 Deadlock/Deadlatch

MODELS & FINISHES		119, 121, 130
4568-011	For door thickness (11) 1-3/4" to 1-15/16"	\$64
4568-012	For door thickness (12) 2" to 2-1/4"	\$75
4568-013	For door thickness (13) 2-15/16" to 2-3/4"	\$75
4568-014	For door thickness (14) 3"	\$75
4569-011	For door thickness (11) 1-3/4" to 1-15/16"	\$70
4569-012	For door thickness (12) 2" to 2-1/4"	\$80
4569-013	For door thickness (13) 2-15/16" to 2-3/4"	\$80
4569-014	For door thickness (14) 3"	\$80

How to Order Specify quantity and the following information. Order related products separately.

PRODUCT NO.	LEVER TYPE	HANDING	DOOR THICKNESS		FINISH
456	8	-5	01		-130
	8 Straight	0 Using MS+1890	FOR 4300, 4500, 4900 Series Deadlatches	FOR MS+1890	119 To match 335 Black Anodized
	9 Return End	5 LH or LHR			121 To match 313 Dark Bronze Anodized
		6 RH or RHR	02 2-1/4" to 2-1/2"	12 2" to 2-1/4"	130 To match 628 Clear Anodized
			03 2-3/4" to 3"	13 2-5/16" to 2-3/4"	
			04 3-1/4"	14 3"	

## 4570 ICU Latch Operator

MODELS & FINISHES		119, 121, 130
4570-01	For door thickness 1-3/4" to 2"	\$225

How to Order Specify quantity and the following information. Order related products separately.

MODEL	FINISH
4570-01	-130
	119 To match 335 Black Anodized
	121 To match 313 Dark Bronze Anodized
	130 To match 628 Clear Anodized



## 4576 ICU Flushbolt with Latch Operator

MODELS & FINISHES		130
4576-X01	For door thickness 1-3/4" to 2"	\$191

How to Order Specify quantity and the following information. Order related products separately.

PRODUCT NO.	HANDING	FINISH
4576	-601	-130
	501 Left Hand	130 To match 628 Clear Anodized
	601 Right Hand	



US [adamsrite.com](http://adamsrite.com) | 800 872 3267 | [customerservice.adamsrite@assaabloy.com](mailto:customerservice.adamsrite@assaabloy.com)  
 CANADA [assaabloydss.ca](http://assaabloydss.ca) | 800 461 3007 | [sales.dss.ca@assaabloy.com](mailto:sales.dss.ca@assaabloy.com)

Patent pending and/or patent [www.assaabloydss.com/patents](http://www.assaabloydss.com/patents). Copyright © 2024, Hanchett Entry Systems, Inc., an ASSA ABLOY Group company. All rights reserved. Reproduction in whole or in part without the express written permission of Hanchett Entry Systems, Inc. is prohibited.

## 4590 Deadlatch Paddle for 4300, 4500, 4900 Deadlatches





MODELS & FINISHES	313, 335, 628
4590-0X-00 For door thickness (00) 1-3/4"	\$125
4590-0X-01 For door thickness (01) 1-13/16" to 2"	\$150
4590-0X-02 For door thickness (02) 2-1/4" to 2-1/2"	\$150
4590-0X-03 For door thickness (03) 2-3/4" to 3"	\$150
4590-0X-04 For door thickness (04) 3-1/4"	\$150



## 4590 Deadlatch Paddle for MS+1890, 2190 Deadlocks

MODELS & FINISHES	313, 335, 628
4590-1X-00 For door thickness (00) 1-3/4"	\$106
4590-1X-01 For door thickness (01) 1-3/4" to 2-1/4"	\$131
4590-1X-02 For door thickness (02) 2-5/16" to 2-1/2"	\$131
4590-1X-03 For door thickness (03) 2-9/16" to 2-3/4"	\$131

How to Order Specify quantity and the following information. Order related products separately.

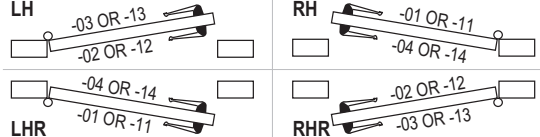
PRODUCT NO.	OPERATION			DOOR THICKNESS		FINISH*
4590	02			-00		-313
	FIRST DASH FOR LATCH SERIES	OPERATION	USE	FOR 4300, 4500, 4900 SERIES Deadlatches	FOR MS+1890, 2190	313 Dark Bronze Anodized 335 Black Anodized 628 Clear Anodized
	-01 4300/4500/4900 -11 MS+1890/2190	PULL TO LEFT 	OUTSIDE of left hand reverse door or inside of right hand	00 1-3/4" 01 1-13/16" to 2"	00 1-3/4" 01 1-3/4" to 2-1/4"	
	-02 4300/4500/4900 -12 MS+1890/2190	PUSH TO LEFT 	OUTSIDE of left hand door or inside of right hand reverse	02 2-1/4" to 2-1/2" 03 2-3/4" to 3"	02 2-5/16" to 2-1/2" 03 2-9/16" to 2-3/4"	
	-03 4300/4500/4900 -13 MS+1890/2190	PULL TO RIGHT 	OUTSIDE of right hand reverse door or inside of left hand	04 3-1/4"		
	-04 4300/4500/4900 -14 MS+1890/2190	PUSH TO RIGHT 	OUTSIDE of right hand door or inside of left hand reverse			
						

\*Finish applied to paddle assembly only, not escutcheon.

## 4591 Deadlatch Paddle for 4300, 4500, 4900 Deadlatches

MODELS & FINISHES	313, 335, 628	US3, US26D
4591-0X-00 For door thickness (00) 1-3/4"	\$153	\$288
4591-0X-01 For door thickness (01) 1-13/16" to 2"	\$178	\$314
4591-0X-02 For door thickness (02) 2-1/4" to 2-1/2"	\$178	\$314
4591-0X-03 For door thickness (03) 2-3/4" to 3"	\$178	\$314
4591-0X-04 For door thickness (04) 3-1/4"	\$178	\$314







## 4591 Deadlatch Paddle for MS+1890, 2190 Deadlocks

MODELS & FINISHES	313, 335, 628	US3, US26D
4591-1X-00 For door thickness (00) 1-3/4"	\$131	\$267
4591-1X-01 For door thickness (01) 1-3/4" to 2-1/4"	\$158	\$292
4591-1X-02 For door thickness (02) 2-5/16" to 2-1/2"	\$158	\$292
4591-1X-03 For door thickness (03) 2-9/16" to 2-3/4"	\$158	\$292

### Options

MODELS	PRICES
4591MA Active paddle, latch activator with monitor switch	Add \$135
4591M Paddle with switch, no latch activator	Add \$117
91-0914 Monitor switch kit for 4591, field installation	\$137

How to Order Specify quantity and the following information. Order related products separately.

PRODUCT NO.	OPTIONS*	OPERATION			DOOR THICKNESS**		FINISH***	
4591	M	02			-00		-313	
	- Standard Paddle	FIRST DASH FOR LATCH SERIES	OPERATION	USE	FOR 4300, 4500, 4900 SERIES DEADLATCHES	FOR MS+1890, 2190	313 Dark Bronze Anodized	
	M Paddle w/ switch only						335 Black Anodized	
	MA Active paddle w/ switch	-01 4300/4500/4900	PULL TO LEFT		OUTSIDE of left hand reverse door or inside OF right hand	00 1-3/4"	00 1-3/4"	628 Clear Anodized
		-11 MS+1890/2190				01 1-13/16" to 2"	01 1-3/4" to 2-1/4"	US3 Bright Brass
		-02 4300/4500/4900	PUSH TO LEFT		OUTSIDE of left hand door or inside of right hand reverse	02 2-1/4" to 2-1/2"	02 2-5/16" to 2-1/2"	US26D Satin Chrome
		-12 MS+1890/2190				03 2-3/4" to 3"	03 2-9/16" to 2-3/4"	
		-03 4300/4500/4900	PULL TO RIGHT		OUTSIDE of right hand reverse door or inside OR left hand	04 3-1/4"		
		-13 MS+1890/2190						
	-04 4300/4500/4900	PUSH TO RIGHT		OUTSIDE of right hand door or inside of left hand reverse				
	-14 MS+1890/2190							

\*M and MA options available on push paddles only, not pull paddles. \*\* M monitor option, switch only, door thickness is not required. \*\*\*Finish applied to paddle assembly only, not escutcheon.

## 4600 Heavy Duty Designer Deadlatch Handles

MODELS & FINISHES		LEVER OPERATOR FOR 4300, 4500, 4900 SERIES DEADLATCHES		LEVER OPERATOR FOR 2190, 2290 INTERCONNECTED DEADBOLT/DEADLATCH	
		10B, US4, US32D	US3, US32	10B, US4, US32D	US3, US32
STANDARD LEVER	4600 Trim with standard lever (01, 02, 03)	\$180	\$224	\$159	\$203
	4600-M Trim with standard lever (01, 02, 03) with form 'C' switch option to indicate when lever is actuated	\$243	\$287	\$222	\$266
	4600-THICK DOOR Trim with standard lever (01, 02, 03) for door thickness greater than 1-7/8"	\$207	\$251	\$186	\$222
DESIGNER LEVER	4600-MX Trim with designer lever series (MD through MW)	\$232	\$276	\$211	\$255
	4600-MX, M Trim with designer lever series (MD through MW) with form 'C' switch option	\$295	\$339	\$274	\$318
	4600-MX, THICK DOOR Trim with designer lever series (MD through MW) for door thickness greater than 1-7/8"	\$259	\$303	\$238	\$282
	4600-MX, M THICK DOOR Trim with designer lever series (MD through MW) or door thickness greater than 1-7/8"	\$322	\$366	\$301	\$345



### Kitted Options

MODELS	PRICES
REX-4600 Request to exit kit	\$53
DTK-4600 Fixed lever (dummy) kit	\$16
TDK-4600-XX Thick door kit. Specify door thickness*	\$36
TBK-4600-XX Through-bolt mounting kit for back-to-back mounting on wood doors. Specify door thickness*	\$36

\*For door thickness (01) 1-3/4", (02) 2", (03) 2-1/4", (04) 2-1/2" and (05) 2-3/4".

How to Order Specify quantity and the following information. Order related products separately.

PRODUCT NO.	REX	HANDLE	HANDING**	DOOR THICKNESS	COMPATIBLE PRODUCTS	FINISH	
4600	M	-01	-5	1	1	-32D	
	(BLANK) Standard	STANDARD HANDLES	5 LH or LHR	1 1-3/4" to 1-7/8"	1 2190, 2290 Interconnected Deadbolt/Deadlatch	US3 Bright Brass	
	M Switch Option	01 Curve	6 RH or RHR	2 2" to 2-1/8"	2 4300, 4500, 4900 Series Deadlatches	US4 Satin Brass	
		02 Round		3 2-1/4" to 2-3/8"		10B Dark Bronze	
		03 Square		4 2-1/2" to 2-5/8"		US32 Bright Stainless	
		DESIGNER SERIES		5 2-3/4" to 2-7/8"		US32D Satin Stainless	
		MD MJ					
		ME MN* (Handed)					
		MG MV* (Handed)					
	MI MW						

\*Handing must be specified for MN and MV Designer Levers. \*\*Handing - assuming lever on interior of door.



# CYLINDERS & ACCESSORIES

## 4024, 4025, 4026 Cylinder Pulls

MODELS & FINISHES	119, 121, 130
4024-00-01, 02 Cylinder pull, Schlage keyway	\$82
4024-06-01, -02 Cylinder pull, Weiser keyway	\$89
4025-00-01, 02 Cylinder pull, Schlage keyway	\$89
4025-06-01, 02 Standard cylinder pull, Weiser keyway	\$89
4025-100-02, CYL X CYL Cylinder both sides pullset, Schlage keyway	\$176
4025-106-02, CYL X CYL Cylinder both sides pullset, Weiser keyway	\$180
4026-00-01, 02 Cylinder pull for use with 5015, 5017 Wood Door Deadlock, Schlage keyway	\$91
4026-06-01, 02 Cylinder pull for use with 5015, 5017 Wood Door Deadlock, Weiser keyway	\$91

Please contact factory for special cylinder requirements.

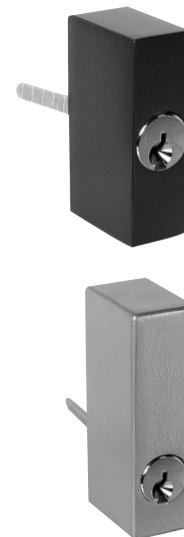

How to Order Specify quantity and the following information. Order related products separately.

PULL TYPE	PULL NO./CYLINDER INCLUDED	KEYING	FINISH
4024	-00	-01	-130
4024 Trim Plate Mounted	00 Schlage "C" Keyway	01 Keyed Different	119 To match 335 Black Anodized
4025 Stile Mounted with through - screws	06 Weiser Keyway	02 Keyed Alike in Pairs	121 To match 313 Dark Bronze Anodized
4026 For Wood Applications			130 To match 628 Clear Anodized

## 4036 Mortise Cylinder

MODEL & FINISHES	313, 335, 628
4036 Five pin cylinder. 2 keys and 1/4" ring, KD, KA2 only For 3300, 3600, 8300, 8400, 8500, 8600, or entry trim. Can be installed directly in latch case of 8400, 8300, or 3300.	\$55

How to Order Specify quantity and the following information. Order related products separately.

PRODUCT NO.	LOCK TYPE	KEY OPTIONS*	FINISH
4036	-01	-01	-628
	01 For MS Locks, Deadlatches, 2190	01 Keyed different	313 Dark Bronze Anodized
	02 For 4070 Deadlock	02 Keyed alike in pairs	335 Black Anodized
	03 For 2331 Deadlock		628 Clear Anodized

\* Keyed alike 50 (KA50) are available by special order in quantity of 50 cylinders only. Please contact factory for ordering information.



## MS4043 Cylinder Guard

MODELS & FINISHES	119, 121, 130
MS4043-00 Cylinder guard, 1/8" stile wall, 5 or 6 pin cylinder	\$46
MS4043-01 Cylinder guard, 1/4" stile wall, 5 or 6 pin cylinder	\$52
MS4043-02 Cylinder guard, 1/8" stile wall, 1-5/16" to 1-7/16" long cylinder	\$73



### How to Order

Specify quantity and the following information. Order related products separately.

PRODUCT NO.	STILE WALL & CYLINDER	FINISH
MS4043	-01	-130
	<b>STILE WALL</b>	<b>CYLINDER</b>
	00 1/8"	5 or 6 pin
	01 1/4"	5 or 6 pin
	02 1/8"	1-5/16" to 1-7/16" long
		119 To match 335 Black Anodized
		121 To match 313 Dark Bronze Anodized
		130 To match 628 Clear Anodized

## 4066 Thumbturn

MODEL & FINISHES	130, 313, 335
4066 Thumbturn cylinder with 1/4" ring	\$55



### How to Order

Specify quantity and the following information. Order related products separately.

PRODUCT NO.	LOCK TYPE	FINISH
4066	-01	-130
	01 For MS Locks, Deadlatches	130 To match 628 Clear Anodized
	02 For 4070 Deadlock	313 Dark Bronze Anodized
	03 For 2331 Deadlock	335 Black Anodized

## 4580 Cam Plug

MODELS	PRICES
4580-X00 Included with lever handles, 1-3/4" door thickness	\$24
4580-X01 Included with lever handles, 2" door thickness	\$24
4580-X02 Included with lever handles, 2-1/4" door thickness	\$34
4580-X03 Included with lever handles, 2-3/4" door thickness	\$34



For "X" specify 5 for LH Door and 6 for RH Door.

## 4581 Universal Cam Plug (used In 4300, 4600, DL100)

MODELS	PRICES
4581-01 Universal cam plug, non-handed, for 1-3/4" door thickness (included in 4600)	\$33
4581-02 Universal cam plug, non-handed, for 2" door thickness	\$42
4581-03 Universal cam plug, non-handed, for 2-1/4" door thickness	\$42



## 8650 Cylinder Escutcheon Kit

MODELS & FINISHES	US32	US4, US32D	119, 121, 130
8650 Cylinder escutcheon kit for 3600, 8500, 8600 exit devices	\$101	\$89	\$45
8650 For wall thickness over 1/8" *	\$140	\$128	\$84

\*Please contact factory for wall thickness greater than 1/8".



## 8736 Rim Cylinder

MODEL & FINISHES	313, 335, 628
8736 Five-pin Rim cylinder for use with 3100, 3700, 8100, 8200, 8700, 8800 exit devices.	\$57

Available keyed different, keyed alike, sets of 2.

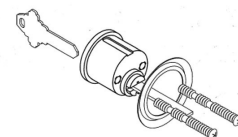

## 4014 Two-Point Conversion Kit

MODEL	PRICE
4014-01 Two-point conversion kit for MS1861 Bottom Rail Deadlock	\$47

## 4015 Threshold Bolt

MODEL & FINISHES	603
4015-18-IB Two-point converter, threshold bolt, standard cylinder height.	\$58
4015-XX-IB Two-point converter, threshold bolt, specify cylinder height greater than 53", 60" maximum.	\$86

Please contact factory for cylinder heights above 53".



### How to Order

Specify quantity and the following information. Order related products separately.

PRODUCT NO.	ADD DASH NUMBER FOR "UNIVERSAL SIZE"	PACKAGING
4015	-18	-IB
		IB Individually Boxed

Please specify cylinder height if ordering in volume quantity.

## 4016 Header Bolt

MODEL	PRICE
4016 Three-point converter, provides upper bolt for MS1850/1870 Deadlocks	\$74

### How to Order

Specify quantity and the following information. Order related products separately.

PRODUCT NO.	LOCK BACKSET	DOOR HEIGHT
4016	-30	-01
	10 1-1/2"	01 7' Door
	20 31/32"	02 10' Door
	30 1-1/8"	



## 4085 Header Bolt (Pairs of Doors Only)

MODELS & FINISHES	PRICE
4085-01-IB Positioner bolt and header strike, specify cylinder height for 7' door height	\$110
4085-02-IB, 4085-03-IB, 4085-04-IB Positioner bolt and header strike, specify cylinder height for door height greater than 7', door height 10' maximum.	\$135

How to Order Specify quantity and the following information. Order related products separately.

PRODUCT NO.	DIMENSION 'A'	PACKAGING
4085	-02	-IB
	01 30" - 52"	IB Individually Boxed
	02 52" - 67"	
	03 67" - 79"	
	04 79" - 92"	

EXAMPLE		
DOOR Height	CYLINDER Height	A
96"	- 40"	= 56"
7' Door is 84" 8' Door is 96" 9' Door is 108" 10' Door is 120"		

Contact factory for door height greater than 7'.



## 4089 Exit Indicator

MODELS & FINISHES	119, 121, 130
4089-00, 4089-01 Indicator for 1-3/4" door, includes both UBC and IBC signs	\$71
4089-20 Indicator for 2" to 2-1/2" door, includes both UBC and IBC signs	\$118

### Accessories

MODELS	PRICES
91-0912 Adapter plate for converting MS1850/4089 installation to deadlatch and lever handle or paddle. Select 121 or 130 finish.	\$43
20-0255-IP Header sign "...During Business Hours"	\$10
20-0256-IP IBC header sign "...Building is Occupied"	\$10

How to Order Specify quantity and the following information. Order related products separately.

PRODUCT NO.	OPTIONS	FINISH
4089	-01	-130
	00 Standard 1-3/4" Door	119 To match 335 Black Anodized
	01 For Inverted Lock	121 To match 313 Dark Bronze Anodized
	20 For Doors up to 2-1/2"	130 To match 628 Clear Anodized



## 4104 Mounting Bridges

MODELS	PRICE
4104-01 Radius mounting bridge	\$14
4104-02 Flat mounting bridge	\$14
4104-03 Left hand bevel mounting bridge	\$14
4104-04 Right hand bevel mounting bridge	\$14



## 91-0965 Universal Mounting Tab Kits for Installing MS® Locks & Latches

MODELS	PRICE
91-0965 Mounting tab kits for flat/radius stiles	\$21
91-0966 Mounting tab kits for beveled stiles, includes tabs for right hand and left hand bevel doors and mounting screws for clear and dark bronze.	\$21



US [adamsrite.com](http://adamsrite.com) | 800 872 3267 | [customerservice.adamsrite@assaabloy.com](mailto:customerservice.adamsrite@assaabloy.com)  
 CANADA [assaabloydss.ca](http://assaabloydss.ca) | 800 461 3007 | [sales.dss.ca@assaabloy.com](mailto:sales.dss.ca@assaabloy.com)

Patent pending and/or patent [www.assaabloydss.com/patents](http://www.assaabloydss.com/patents). Copyright © 2024, Hanchett Entry Systems, Inc., an ASSA ABLOY Group company. All rights reserved. Reproduction in whole or in part without the express written permission of Hanchett Entry Systems, Inc. is prohibited.

UPDATED April 16, 2024

## B1921, B1923 Reinforcing Pivots

MODELS & FINISH	PRICE
B1921 1/2" offset to match pivot point of 4" wide butt hinge	\$110
B1923 3/4" offset to match pivot point of 4-1/2" wide butt hinge	\$97



How to Order Specify quantity and the following information. Order related products separately.

PRODUCT NO.	MODEL
B192	1
	1 4"
	3 4-1/2"

## STRIKES

### 2190 Dual Force® Interconnected Deadbolt/Deadlatch Strikes

MODELS & FINISHES	630	119, 121
2101-01 Standard flat strike with dust box	\$34	\$42
2101-02 Standard radius strike with dust box	\$34	\$42
MODELS & FINISHES	630	121
2101-21* Strike with extended lip, 4.5" only, flat strike	\$52	\$61
2102-01 Retrofit strike extended height 7-5/8" with dust box	\$48	\$57

\*Contact factory for available sizes.

### 2290 Dual Force® Interconnected Deadbolt/Deadlatch Strikes

MODELS & FINISHES	630	119, 121
2206-01 Standard flat strike with dust box	\$34	\$42
2206-21* Strike with extended lip, specify dimension from strike centerline to frame face, to 4.5" maximum, flat strike only	\$52	

\*Contact factory for available sizes.

### 4000 Series MS® Deadlock Strikes

MODELS & FINISHES	630	313, 335, 628	US3, US26D	119, 121
4000 Trim Strike		\$36		
4001 Box Strike, includes dust box		\$46	\$73	
MS4002 Armored Strike		\$72	\$98	
4003 ANSI strike, available in 121 or US26D only			\$88	\$88
4005 Strike for 4015 Threshold Bolt	\$27			
4006 Strike for 1830 Bottom Rail Deadlock	\$55			\$64
4009-01 Open back strike for 3300, 8300 Series Mortise Exit Device	\$174			
4170 Trim strike for 4070 Short Throw Deadbolt, not available in 335 finish		\$37		\$37
4505-01 Flat armored box strike for MS+1890 Deadlock/Deadlatch	\$62			\$70
4505-02 Radius armored box strike for MS+1890 Deadlock/Deadlatch	\$62			\$70
4505-17, 4505-21 Flat long lip armored box strike, 4" or 4.5" Respectively	\$78			\$86



How to Order Specify quantity and the following information. Order related products separately.

STRIKE MODEL	TRIM PLATE SHAPE	COMPATIBLE DEADLOCK	TRIM PLATE CORNERS	FINISH
4001	-0	1	1	-313
4000 Trim Strike	0 Flat	1 All Standard MS® locks with 1-3/8" Bolt Throw	1 Square	03 Bright Brass (US3)
4001 Box Strike	1 Radius	2 1850A-020 with 3/4" Bolt Throw Only	2 Round	313 Dark Bronze Anodized
MS4002 Armored Strike		3 All MS-050 Hookbolt locks		335 Black Anodized
				628 Clear Anodized
				US26D Satin Chrome

US adamsrite.com | 800 872 3267 | customerservice.adamsrite@assaabloy.com  
CANADA assaabloydss.ca | 800 461 3007 | sales.dss.ca@assaabloy.com

Patent pending and/or patent www.assaabloydss.com/patents. Copyright © 2024, Hanchett Entry Systems, Inc., an ASSA ABLOY Group company. All rights reserved. Reproduction in whole or in part without the express written permission of Hanchett Entry Systems, Inc. is prohibited.

UPDATED April 16, 2024



## 4800, MS4804 Series Strikes

MODELS & FINISHES	603	630
MS4804-10-630 Reinforcing strike and screws, two-part with reinforcement for strengthening metal jamb		\$27
4801 Metal strike, specify dash number indicating shim quantity	\$23	\$30
4802 Wood strike, specify dash number indicating shim quantity	\$23	
4810-01, 4810-02 Box strike for 5017 Wood Door Deadlock/Deadlatch	\$23	



How to Order Specify quantity and the following information. Order related products separately.

PRODUCT NO.	TYPE OF JAMB	DIMENSION 'A'	FINISH
480	1	-02	-630
	1 Metal	01 3/32"	603 Zinc Plated Steel
	2 Wood	02 3/16"	630 Satin Stainless
		03 9/32"	

4802 only available in 603 finish.

## 4901, 4902 Deadlatch Strikes

MODELS & FINISHES	630	119, 121
4901-01 Flush mount flat strike, mortised with dust box	\$24	\$30
4901-02 Flush mount radius strike, mortised with dust box	\$24	\$30
4901-XX Extended lip strike, specify lip dim 'A', 2.5" maximum*	\$47	\$51
4902-01 Short box strike, flat with dust box, mounting plate	\$24	\$30
4902-02 Short type box strike, radius with dust box, mounting plate	\$24	\$30
4902-XX Extended lip strike, specify lip dim 'A', 2.5" maximum*	\$47	\$59
4506-02 Strike for use with 4920AN, not available in 119 finish	\$47	\$55



\*See dim. 'A' dash chart table below.

How to Order Specify quantity and the following information. Order related products separately.

PRODUCT NO.	STRIKE TYPE	FACEPLATE SHAPE				FINISH
490	1	-02				630
		STANDARD LIP				119 To match 335 Black Anodized
	1 Long	01	Flat		121 To match 313 Dark Bronze Anodized	
	2 Short	02	Radius		630 Satin Stainless Steel	
		LONG LIP FOR CENTER HUNG DOOR		LONG LIP FOR CENTER HUNG DOOR		
			DIM. 'A'		DIM. 'A'	
		03 2-1/4" Wide Jamb	1-1/8	13 3-1/2" Wide Jamb	1-3/4	
		05 2-1/2" Wide Jamb	1-1/4	15 3-3/4" Wide Jamb	1-7/8	
		07 2-3/4" Wide Jamb	1-3/8	17 4" Wide Jamb	2	
		09 3" Wide Jamb	1-1/2	19 4-1/4" Wide Jamb	2-1/8	
		11 3-1/4" Wide Jamb	1-5/8	21 4-1/2" Wide Jamb	2-1/4	

## 4304 Deadlatch Strikes

MODEL & FINISHES	630	119, 121
4304 Surface mount strike for 4300 Electrified Deadlatch	\$27	\$35

## THICK DOOR KITS

### 2190, 2290 Dual Force® Interconnected Deadbolt/Deadlatch Thick Door Kit

MODELS	PRICE
2190-TDK-XX Thick door kit for 2190, 2290 standard exterior trim set. Specify door thickness.*	\$77
2190-TDK-CL1, -CL2 Thick door kit for 2190, 2290 cladded doors. CL-1 for a standard 1-3/4" thick door with 1/4" cladding. CL-2 for a standard 1-3/4" thick door with 1/2" cladding.	\$77
TDK-4600-XX Thick door kit for 2190, 2290 low profile trim set. Specify door thickness.*	\$36

\*For door thickness (01) 1-3/4", (02) 2", (03) 2-1/4", (04) 2-1/2", (05) 2-3/4", (06) 3", (07) 3-1/4".

### 4568, 4569 Eurostyle Deadlatch Handle Thick Door Kits

MODELS	PRICE
91-0128-02, 91-0128-03, 91-0128-04 Thick door kits for 4568, 4569	\$26
26-0203-01, 26-0203-02, 26-0203-03 Thick door kits for 4568-11, 4569-11	\$26

## FACEPLATES

### MS1850S Deadlock Faceplates

MODELS & FINISHES	313, 628
BFK-MS1850-10 Blank faceplate kit, flat, 1" x 6-7/8"	\$29
BFK-MS1850-11 Blank faceplate kit, radius, 1" x 6-7/8"	\$29

### MS1850S, MS1950P Deadlock (Standard Bolt) Faceplates

MODELS & FINISHES	313, 335, 628
24-0384-010 Flat faceplate	\$10
24-0384-110 Radius faceplate	\$10
24-0384-210 Left hand bevel faceplate	\$10
24-0384-310 Right hand bevel faceplate	\$10
24-0384-410 Radius with weatherstrip	\$15
SPECIAL MODELS	313, 628
24-0384-110-313-B100, 24-0384-110-628-B100 Radius faceplates, bulk package of 100 units	\$850
24-0384-210-313-B100, 24-0384-210-628-B100 Left hand bevel faceplates, bulk package of 100 units	\$850
24-0384-310-313-B100, 24-0384-310-628-B100 Right hand bevel faceplates, bulk package of 100 units	\$850
24-0384-410-313-B100, 24-0384-410-628-B100 Radius with weatherstrip faceplates, bulk package of 100 units	\$1,167

Please note that all 100 faceplates in the bulk package are of the same finish.



## MS1850S, MS1950P Deadlock (Hookbolt and Short Bolt) Faceplates

MODELS & FINISHES	313, 335, 628
24-0384-020 Flat faceplate	\$10
24-0384-120 Radius faceplate	\$10
24-0384-220 Left hand bevel faceplate	\$10
24-0384-320 Right hand bevel faceplate	\$10
24-0384-420 Radius with weatherstrip	\$15
SPECIAL MODELS	313, 628
24-0384-020-313-B100, 24-0384-020-628-B100 Flat faceplates, bulk package of 100 units	\$850
24-0384-120-313-B100, 24-0384-120-628-B100 Radius faceplates, bulk package of 100 units	\$850
24-0384-220-313-B100, 24-0384-220-628-B100 Left hand bevel faceplates, bulk package of 100 units	\$850
24-0384-320-313-B100, 24-0384-320-628-B100 Right hand bevel faceplates, bulk package of 100 units	\$850
24-0384-420-313-B100, 24-0384-420-628-B100 Radius with weatherstrip faceplates, bulk package of 100 units	\$1,167

Please note that all 100 faceplates in the bulk package are of the same finish.

## MS1850SN410 Deadlock (Standard Bolt) Faceplates

MODELS & FINISHES	313, 335, 628
24-0226-010 Flat faceplate	\$15
24-0226-110 Radius faceplate	\$15

## MS1850SN450 Deadlock (Hookbolt) Faceplates

MODELS & FINISHES	313, 335, 628
24-0226-020 Flat faceplate	\$15
24-0226-120 Radius faceplate	\$15

## 1870 Flushbolt Faceplates

MODELS & FINISHES	313, 335, 628
24-0168-00 Flat faceplate	\$23
24-0168-01 Radius faceplate	\$23
24-0168-02 Left hand bevel faceplate	\$23
24-0168-03 Right hand bevel faceplate	\$23
24-0168-04 Radius with weatherstrip	\$26

## MS+1890 Deadlock Faceplates

MODELS & FINISHES	313, 335, 628
24-0270-020 Flat faceplate	\$14
24-0270-120 Radius faceplate	\$14
24-0270-220 Left hand bevel faceplate	\$14
24-0270-320 Right hand bevel faceplate	\$14
24-0270-420 Radius with weatherstrip	\$19

## 2190 Dual Force® Interconnected Deadbolt/Deadlatch Faceplates

MODELS & FINISHES	313, 628
91-0266-01-313-IP, 91-0266-01-628-IP Flat faceplate and radius faceplate kit for aluminum (2190)	\$48
91-0266-04-313-IP, 91-0266-04-628-IP Flat faceplate and radius faceplate kit for wood or hollow metal (2290)	\$48

## 2331 Heavy Duty Deadbolt Faceplates

MODELS & FINISHES	121	US26D	US3
22-0170 Flat faceplate	\$48	\$48	\$53
22-0032 Strike plate	\$48	\$48	\$53

## 3300 Fire-Rated Mortise Exit Device Faceplates

MODEL & FINISHES	335, 628
24-0015-020 Flat faceplate	\$13

## 4070 Short Throw Deadbolt Faceplates

MODELS & FINISHES	313, 335, 628
24-0136-00 Flat faceplate	\$14
24-0136-10 Radius faceplate	\$14
24-0136-20 Left hand bevel faceplate	\$14
24-0136-30 Right hand bevel faceplate	\$14

## 4500 Standard Duty Deadlatch Faceplates

MODELS & FINISHES	313, 335, 628
24-0017-0220 Flat faceplate	\$10
24-0017-1220 Radius faceplate	\$10
24-0017-2220 Left hand bevel faceplate	\$10
24-0017-3220 Right Hand bevel faceplate	\$10
24-0017-4220 Radius with weatherstrip	\$15

## 4530 Standard Duty Deadlatch Faceplates

MODELS & FINISHES	313, 335, 628
24-0016-020 Flat faceplate	\$19
24-0016-120 Radius faceplate	\$19
24-0016-220 Left hand bevel faceplate	\$19
24-0016-320 Right hand bevel faceplate	\$19

## 4900 Heavy Duty Deadlatch Faceplates

MODELS & FINISHES	313, 335, 628	US4, US26D	US3, US26
24-0137-01 Flat or bevel faceplate	\$10	\$39	\$44
24-0137-02 Radius faceplate	\$10	\$39	\$44
24-0137-03 Radius with weatherstrip	\$15		

## 4900 Heavy Duty Deadlatch Special Faceplates

MODELS & FINISHES	313, 628
24-0140 Radius with weatherstrip seal (1-1/8" x 6-7/8")	\$23
24-0144-01 Flat or beveled doors (1-1/8" x 7-1/4")	\$19

## 4920, 8300 Faceplates

MODEL & FINISHES	313, 335, 628
24-0138-01 Flat or bevel faceplate	\$30

## 7100, 7160 Electric Strike Faceplates

MODEL & FINISHES	313, 335, 628
24-0685-01 Round corner faceplate (1-1/4" x 4-7/8")	\$28

## 7101 Electric Strike Faceplates

MODEL & FINISHES	313, 335, 628
24-0685-02 Radius faceplate (1-1/4" x 4-7/8")	\$28

## 7110 Electric Strike Faceplates

MODEL & FINISH	652
22-0558 Round corner faceplate (1-7/16" x 7-15/16")	\$28

## 7111 Electric Strike Faceplates

MODEL & FINISH	652
22-0557-01-652 Round corner faceplate (1-7/16" x 10-1/4")	\$28

## 7130 Electric Strike Faceplates

MODEL & FINISHES	313, 335, 628
24-0686-01 Round corner faceplate (1-1/4" x 6-7/8")	\$34

## 7131 Electric Strike Faceplates

MODEL & FINISHES	313, 335, 628
24-0686-02 Radius faceplate (1-1/4" x 6-7/8")	\$34

## 7140, 7170 Electric Strike Faceplates

MODEL & FINISHES	313, 335, 628
24-0687-01 Radius faceplate (1-1/4" x 4-7/8")	\$28

# POWER

## PS-1 Power Supply

MODEL	PRICE
PS-1 Power supply, 12/24 VDC boxed P/S 1 Amp	\$370

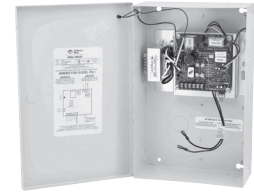

## PS-EXIT Power Supply

MODEL	PRICE
PS-EXIT Power Supply for exit devices with Motorized Latch Retraction (MLR) and Electric Latch Retraction (LR) options.	\$750

*Adams Rite PS-LR and PS-SE were discontinued as of November 2020. Customers can now order the PS-EXIT. BBK-EXIT has been discontinued.*



## 4612 Power Transfer Device

MODELS	PRICE
4612-1 Wire transfer, 105° swing	\$193
4612-2 Wire transfer, 180° swing	\$247
4612-1SC Wire transfer, swing clear 90° swing	\$331
4612EL-1 Wire transfer, 105° swing with ElectroLynx(TM) Adapter	\$226
4612EL-1SC Wire transfer, 90° swing with ElectroLynx(TM) Adapter	\$362



## Accessories for Power

MODELS	PRICE
4603 Rectifier	\$21
4605 Transformer, 115 VAC to 12/24 VAC	\$69
4606 Plug-in transformer, 115 VAC to 24 VAC only	\$111
29-0218 Piezo electric horn	\$27
ELX ElectroLynx™ Adapter to connect Adams Rite products to the ElectroLynx system	\$39

# DEMO MOUNTS

## DEADLOCKS & DEADLATCHES

### 2190 Dual Force® Interconnected Deadbolt/Deadlatch

MODELS & FINISH	US32D
2190-MOUNT Dual Force® 2190 Interconnected Deadbolt/Deadlatch mounted complete with electrified trim set	\$1,195

### 4300 Steel Hawk® Electrified Deadlatch

MODELS & FINISH	US32D
4300-MOUNT Electrified Deadlatch with EcoLatch® technology mounted complete with 4600 Heavy Duty Designer Deadlatch Lever Trim with MN designer lever	\$1,025

### DL100 Aperio® Wireless Deadlatch

MODELS & FINISH	PRICE
DL100-MOUNT Electrified Deadlatch with EcoLatch® technology mounted complete with 4600 Heavy Duty Designer Deadlatch Lever Trim with MN designer lever	\$1,441

## ELECTRIC STRIKES

### 7400 UltraLine® Preload-Capable Electric Strike

MODELS & FINISH	PRICE
7440-MOUNT UltraLine® 7440 Electric Strike mounted complete with 4-7/8" faceplate, 628 finish	\$917
74R1-MOUNT UltraLine® 74R1 Electric Strike for rim exit devices with 3/4" Pullman latches mounted complete, 130 finish	\$968
74R2-MOUNT UltraLine® 74R2 Electric Strike for rim exit devices with 1/2" Pullman latches mounted complete, 130 finish	\$968

## TRIM

### 3090 eForce® Keyless Entry

MODELS & FINISH	626
3090-MOUNT eForce® 3090-150 Keyless Entry Trim mounted complete with 4900 Heavy Duty Deadlatch	\$1,664

### 4600 Heavy Duty Designer Deadlatch Handles

MODELS & FINISH	US32D
4600-MOUNT 4600 Heavy Duty Designer Deadlatch Lever Trim with MN designer levers, mounted complete with Dual Force® 2190 Deadbolt/Deadlatch (lock)	\$1,163

# GENERAL INFORMATION

## Limited Warranty

Adams Rite warrants that its products sold under the Adams Rite brand in the United States of America are warranted free from defects in workmanship and materials under normal use and service. This warranty does not cover defects or damage arising from improper installation, lack of or improper maintenance, improper storage, shipping and handling, corrosion, erosion, ordinary wear and tear, misuse, abuse, accident, unauthorized service, or use with unauthorized non-Adams Rite products or parts. This warranty is void if any modification is made to the product, regardless of whether the modification causes or contributes to the alleged defect. All modifications are made at the risk of the party making the modification.

Should any defect of manufacture (in material or workmanship) occur in its products, Adams Rite, upon prompt notification and proof to its satisfaction that the product was defective in manufacture for the use intended by Adams Rite, will at its option, exchange the product, repair the product, or refund the price charged by Adams Rite, FOB factory within the stated time frame listed below.

- **10 years** on all mechanical products from the date of manufacture
  - **5 years** on the following electromechanical product categories from the date of manufacture, deadlocks, dead latches, exit devices\*, electric strikes, trims, power supply & accessories
- \* **NOTE:** The MLR option (motorized electric latch retraction) is supported by a 1-year electro mechanical warranty. When powered by an Adams Rite PS-EXIT power supply the 1-year warranty is upgraded to 5 years
- **3 years** on the following access control products from the date of manufacture, DL100 Aperio Wireless Dead Latch, 3090-150.

THIS WARRANTY IS IN LIEU OF ALL OTHER EXPRESS WARRANTIES. TO THE EXTENT PERMITTED BY LAW, ALL IMPLIED WARRANTIES ARE LIMITED TO THE DURATION OF THIS WARRANTY. ADAMS RITE IS A DIVISION OF HANCHETT ENTRY SYSTEMS, INC. HANCHETT ENTRY SYSTEMS, INC. SHALL NOT BE LIABLE FOR ANY INCIDENTAL OR CONSEQUENTIAL DAMAGES. SOME STATES DO NOT ALLOW LIMITATIONS ON HOW LONG AN IMPLIED WARRANTY LASTS OR THE EXCLUSION OR LIMITATION OF INCIDENTAL OR CONSEQUENTIAL DAMAGES, SO THE ABOVE LIMITATION OR EXCLUSIONS MAY NOT APPLY TO YOU. THIS WARRANTY GIVES YOU SPECIFIC LEGAL RIGHTS, AND YOU MAY ALSO HAVE OTHER RIGHTS WHICH VARY FROM STATE TO STATE.

## Terms & Conditions

**PRICES:** All prices are subject to change without notice. Prices listed on the Adams Rite website will serve as the most current list price. All shipments will be made at prices in effect at the time of order. The customer shall be responsible for payment of all applicable sales and/or use taxes and freight costs.

**MINIMUM ORDER:** Minimum product charge per invoice is \$150.00 USD.

**PAYMENT TERMS:** Net thirty (30) days from date of invoice. Interest at the rate of up to 1-1/2% per month may be charged on all past due accounts. An order received on an account which has not been paid within 45 days of the date of invoice may not be processed until the account is current. Custom orders may require a deposit.

**DELIVERY TERMS:** All prices are Ex-works factory. Purchaser assumes the risk of loss or damage to the goods while in transit from the point of shipment. Adams Rite reserves the right to make delivery in installments. Installments shall be separately invoiced and paid for when due. Delay in delivery of an installment shall not relieve the purchaser of its obligation to accept remaining deliveries.

**FREIGHT POLICY:** All Purchase Orders received with a minimum net value of \$ 3,500 will qualify automatically for free standard freight within the continental United States. This minimum amount applies per Purchase Order to qualify and does not include free expedited freight. Qualified orders may ship partial or ship complete at your preference. Qualified orders that ship partial will not incur freight charges. All shipments that do not qualify for free freight will be charged for freight based upon our terms in effect at the time of shipment. Customers may provide their own carrier account number for expedited freight methods or for any Purchase Order to be used to cover freight costs. Minimum amounts are subject to change without notice.

**SHORTAGE:** Any claim for shortages must be made to Adams Rite in writing within one (1) week of receipt of merchandise.

**WARRANTY RETURNS:** A Customer Care Form (CCF) for defective product must be obtained from Alarm Controls before any merchandise can be returned. CCF's are valid for sixty (60) days from date of issuance Goods returned under the terms of Adams Rite Warranties may require a copy of the original invoice.

**RETURNS:** A Customer Care Form (CCF) must be obtained from Adams Rite before any merchandise can be returned. CCF's are valid for sixty (60) days from date of issuance. Items returned are subject to restocking fees.

**CANCELLATIONS:** Any order may be subject to a 5% cancellation charge for catalog items. Cancellation of non-catalog or custom items will be subject to a 20% cancellation charge plus all costs (both direct and indirect) incurred by manufacturing at the point of cancellation that are properly allocated to the canceled item(s).

**LIMITATION OF LIABILITY:** Neither party will be liable to the other for any delay or failure in performance arising directly out of war, sabotage, insurrection, riot, and any other act of civil disobedience, act of public enemy, fire, explosion, flood, storm, or other act of God or nature, or similar cause beyond its reasonable control, including shortage or unavailability of labor or materials. If, notwithstanding the foregoing limitations, Adams Rite has any liability to the purchaser, the purchaser agrees that the total liability to the purchaser for all losses, damages, and causes of action, whether in contract, equity, tort (including without limitation, negligence and gross negligence), or otherwise, will not exceed the amount the purchaser paid to Adams Rite for the products (including, without limitation, incidental or consequential damages, damages for lost profits or business interruption, and punitive damages).

**NO THIRD PARTY LIABILITY:** If the purchaser uses the Adams Rite Products on behalf of others or provides to others any products referenced herein, the Adams Rite Parties shall have no liability to such persons whatsoever, and the purchaser agree to defend and indemnify the Adams Rite Parties from any and all claims and demands asserted against them, and from any legal fees, costs and other expenses that the Adams Rite Parties incur therewith.





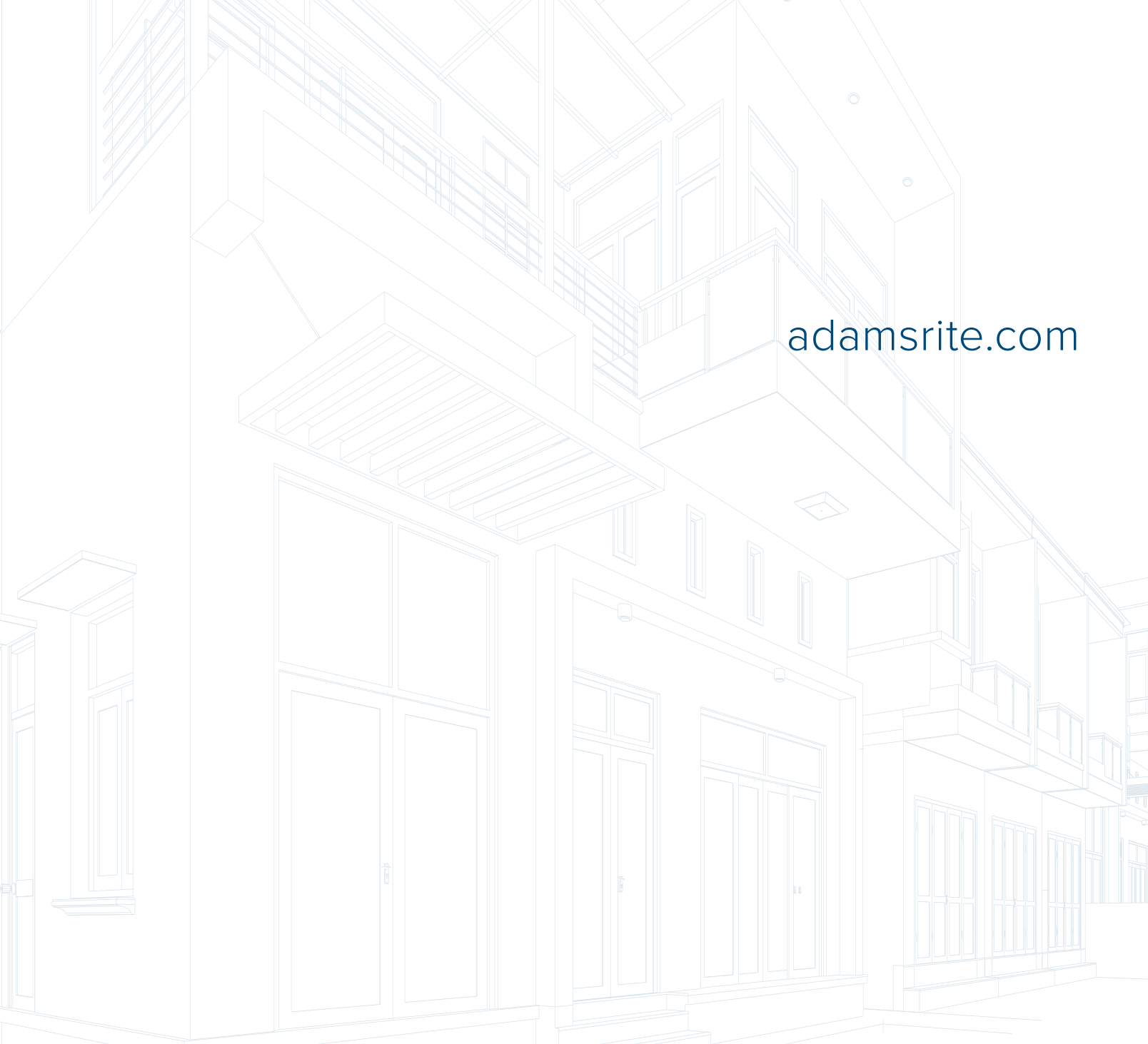

[adamsrite.com](http://adamsrite.com)



ASSA ABLOY

The ASSA ABLOY Group is the global leader in access solutions. Every day we help people feel safe, secure and experience a more open world.

## USA

800.872.3267 | f: 800.232.7329 | [adamsrite.com](http://adamsrite.com)

[customerservice.adamsrite@assaabloy.com](mailto:customerservice.adamsrite@assaabloy.com)

[techsupport.adamsrite@assaabloy.com](mailto:techsupport.adamsrite@assaabloy.com)

[orders.adamsrite@assaabloy.com](mailto:orders.adamsrite@assaabloy.com)

## Canada

800.461.3007 | f: 800.461.8989 | [assaabloydss.ca](http://assaabloydss.ca)

[sales.dss.ca@assaabloy.com](mailto:sales.dss.ca@assaabloy.com)

[orders.dss.ca@assaabloy.com](mailto:orders.dss.ca@assaabloy.com)

Patent pending and/or patent [www.assaabloydss.com/patents](http://www.assaabloydss.com/patents).

Copyright © 2024, Hanchett Entry Systems, Inc., an ASSA ABLOY Group company.

All rights reserved. Reproduction in whole or in part without the express written permission of Hanchett Entry Systems, Inc. is prohibited. AR-082-0524

[adamsrite.com](http://adamsrite.com)

Experience a safer  
and more open world