

ACCENTRA

ASSA ABLOY

Residential Mechanical Price Book

Volume 1

Effective date March 1, 2024

US ONLY



Finishes

Please check each product's specifications for availability.

Navis Paddle

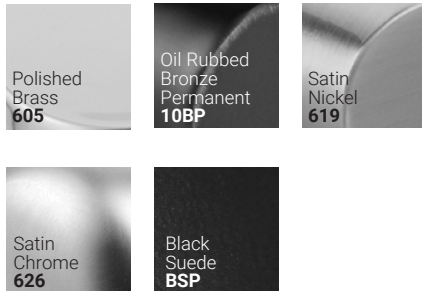

Heritage Collection

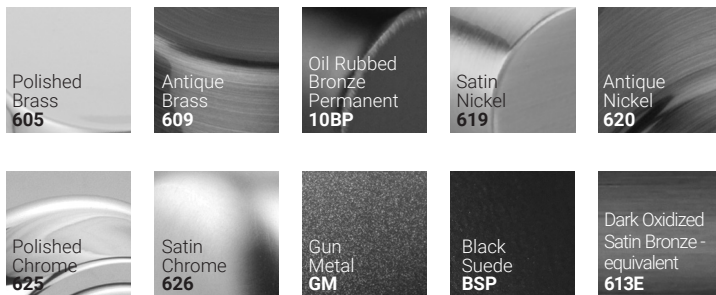

Contents

Terms of Sale Ordering Information	3
Heritage Collection Grade 2 Interconnected Mechanical	9
Navis Paddle	14
Heritage Collection Grade 2	
Knobs	16
Bridgeport, Dartmouth, Cambridge, Oxford	
Levers	19
Academy, Augusta, Charleston, Delaware, Kincaid, Marina, McClure, Milan, Monroe, Norwood, Pacific Beach, Valdosta, Virgo	
Deadbolts	24
Latches	27
Heritage Collection Grade 3	
Knobs	28
Cirrus, Horizon, Oasis, Terra, Valley	
Levers	31
Mesa, Niagara, Prairie, Savannah, Vidalia, Woodland	
Deadbolts	34
Latches	37
Decorative Handlesets	38
Homestead, Jamestown, McKinley, Pedestal, Rainier, Ridgefield, Teton	
Handing	10, 20, 32
Accessories	42
Keying Information	43
UL Ratings	6

ASSA ABLOY ACCENTRA™

Terms and Conditions of Sale

Terms & Conditions

Minimum freight requirements apply. The Terms and Conditions contained on the ASSA ABLOY ACCENTRA™ Website, as published from time to time, shall apply to all purchases of Goods. To the extent that any terms in any invoice conflict with the terms of the Price List, the terms of the Price List shall govern.

Applicable Law; Definitions

All sales of ACCENTRA branded goods ("Goods") shall be governed by the laws of the State of Connecticut, including the Uniform Commercial Code as in effect in Connecticut on the date of sale (the "Code"). Whenever a term defined by the Code is used in these Terms and Conditions of Sale, the definition contained in the Code shall apply here. The purchaser of the Goods agrees that any proceeding brought in connection with the purchase of the Goods shall be brought in any court of competent jurisdiction in Connecticut.

Purchase Price

The purchase price of the Goods is subject to change without notice, and the prices prevailing at the time the Goods are shipped by ACCENTRA shall apply unless ACCENTRA has agreed in writing to a different price or has given a prior written quotation which constitutes a firm offer. ACCENTRA does not guarantee that the price, terms and conditions for reorders of the Goods will be the same as contained in the ACCENTRA Price List. Rebates or refunds for Goods that represent dealer stock on hand or for Goods already shipped by ACCENTRA will not be given due to any price reduction. The purchase price for any Goods purchased shall be due as and when specified in the invoice covering such Goods. Title to the Goods shall not pass to purchaser until full payment for the Goods is made to ACCENTRA.

Binding for all Purchases

All orders, whether solicited or written by our representatives or delivered by you are deemed offers by you to purchase our products. Our acceptance of each such offer is expressly subject to and conditioned on your assent to the Terms and Conditions of Sale contained herein (assent may be deemed to occur if we do not receive a written objection or retraction of such offer within 48 hours after you receive our confirmation of receipt of such offer). No other terms or conditions shall apply.

Prices and Minimum Charges

All prices are subject to change without notice and are not guaranteed. All shipments will be made at prices in effect at the time of shipment. Possession of this price list does not constitute an agreement to sell. We reserve the right to correct clerical, stenographic and other obvious errors at any time.

Minimum order value for complete product is \$250.00 net product value. The minimum order value for parts orders is \$100.00 net product value. In the event that the net product value does not meet the required net minimum, ASSA ABLOY ACCENTRA™ may, at its sole discretion (a) apply a minimum order charge, (b) reject the order or (c) waive the minimum requirement provided that the waiver of the requirement for one order shall not constitute a waiver of the requirement for any future orders. The following products are exempt from this policy: Cut (bitted) keys of any type, Master keys, Master keyed cylinders or padlocks and factory generated bitting lists.

Payment

Standard sales terms are 2/10 net 30. The 2.0% discount only applies for invoices paid in full within 10 days of invoice date. Invoices not paid in full within 30 days of invoice date shall incur a service charge of 1.5% per month for each month or fraction thereof (or the maximum rate permitted by law) until paid in full. All delinquent accounts are subject to credit hold.

Freight

All orders are shipped FOB factory/warehouse, except as expressly provided below. When delivered to the Transportation Company, the

Purchaser assumes the risk of loss or damage in transit.

Customer orders with net product value in excess of \$7,000.00 will be shipped prepaid by the ACCENTRA carrier of choice to a single destination point in the United States.

Customer orders with net product value less than \$7,000.00 will be shipped prepaid by the ACCENTRA carrier of choice and freight and handling charges will be added to the customer's invoice. A minimum freight and handling charge of \$15.00 will be charged on orders with net product value of \$400.00 or less. The minimum freight and handling charge will not apply to orders for only Cut (bitted) keys of any type, Master keys, Master keyed cylinders or padlocks and factory generated bitting lists that do not have any other product types included on the order. Freight on these orders will be charged as the percentage of invoice value.

For orders with net product value greater than \$400.00 and less than \$7,000.00, freight charges will be calculated as a percentage of the net invoice value and will be added to Customer's invoice. The percentage is based on the National U.S. Average On Highway Diesel Fuel Prices as reported by the US Department of Energy in effect at the beginning of each quarter. On the first Monday of each quarter, the new rate will be published on the ACCENTRA and Door Security Solutions extranet and will go into effect on the 2nd Monday of the quarter. Please refer to the ACCENTRA distributor extranet for the rate chart and information on the current freight charge percentage. The percentage in effect at the time of shipment of the order will be charged. Great Grand Master keys, Grand Master keys, Master keys, Construction Master keys, Control Keys, and Change Keys which are shipped separate from customer order for security reasons, on orders with total net product value in excess of \$7,000.00 will be shipped prepaid by the ACCENTRA carrier of choice. If the total order value is less than \$7,000.00, the shipping charges will be added to Customer's invoice.

If a customer provides their own freight account number for the freight charges, ACCENTRA will apply a handling fee of \$25.00 to the invoice.

Expedited shipping options – If the customer requests an expedited method of shipment such as "Next Day Air" the charges will be prepaid by ASSA ABLOY ACCENTRA™ and the full rate for the service, as published by the carrier, will be added to the customer's invoice.

Packing – ACCENTRA will pack, mark and ship the products according to its standard procedures for shipment, unless the parties agree, in writing, that ASSA ABLOY ACCENTRA™ will comply with any special instructions provided by the customer. Special instructions must be submitted, in writing, at time of order placement. Compliance with special instructions may result in an increased price.

Discrepancies must be noted with carrier upon receipt as they are your responsibility to claim.

Minimum Annual Purchase Requirement

We may discontinue direct sales to you if you do not meet the minimum annual purchase requirement (currently \$10,000), based on total accepted, shipped and non-canceled orders within each calendar year.

Limited Warranty

ASSA ABLOY ACCENTRA (the "Warrantor") warrants that its products sold under the ASSA ABLOY ACCENTRA brand name in the United States of America & Canada are free from defects in workmanship and materials under normal use and service.

The only liability of the Warrantor in tort or contract whether under this warranty or otherwise shall be limited to the repair or replacement of any product or component part which shall prove defective as covered by this warranty, within the stated time frame listed below, after delivery to the original purchaser.

ASSA ABLOY ACCENTRA™

Terms and Conditions of Sale

1. MECHANICAL PARTS & FINISH.

ACCENTRA, extends the following LIMITED WARRANTY to the original purchaser for a single family home, (herein the "lockset" or "locksets") shipped to, and installed in the U S or Canada. Because the Company cannot control the quality of Devices sold by unauthorized sellers, this Warranty applies only to Devices purchased from ACCENTRA or an ACCENTRA authorized seller in the United States of America, unless otherwise prohibited by law. ACCENTRA reserves the right to reject warranty claims from purchasers for Devices purchased from unauthorized sellers, including unauthorized internet sites.

ASSA ABLOY ACCENTRA provides a ONE (1) YEAR warranty on finish and TWO (2) YEAR warranty on mechanical Devices for collections listed below:

Heritage Collection Grade 2
Heritage Collection Grade 3
Navis Paddle

2. CONDITIONS AND EXCEPTIONS.

This Limited Warranty shall apply only when the lockset is properly installed in accordance with local codes, ordinances and regulations, the printed instructions provided with it and good industry practices. THIS WARRANTY DOES NOT COVER defects caused by: modification, alteration, repair or service of the lockset by anyone other than Warrantor or an authorized designee of Warrantor; physical abuse to, or misuse of, the lockset or operation of it in a manner contrary to the accompanying instructions; shipment of the product to anyone other than Warrantor for service; improper installation; acts of God; fire; flood; casualty; failure to exercise normal maintenance; for the consequences of uses for which locksets were not designed or designated, or for defects caused by the use of paints, solvents or other chemicals which come in contact with the lockset. THIS WARRANTY DOES NOT COVER scratches or abrasions. THIS WARRANTY DOES NOT APPLY to locksets or component parts of locksets that were not originally manufactured by Warrantor. THIS WARRANTY SHALL NOT APPLY TO SUBSEQUENT OWNERS.

3. SERVICE AND REPAIR EXPENSE.

Under this Limited Warranty the Warrantor will provide only a replacement lockset or a part of it. Warrantor will pay reasonable shipping costs for surface transportation only for locksets returned to Warrantor's Customer Service Department. Warrantor will ship replacement parts under this Limited Warranty at its expense by surface transportation only. Any special handling, express or expedited service or different method of transportation shall only be provided at the request and expense of the purchaser of the locksets. However, if warrantor determines that a lockset does not qualify for repair or replacement under the applicable Limited Warranty, Warrantor will notify the consumer of the estimated costs of repair or replacement and obtain the consumer's authorization and agreement to pay actual repair or replacement costs before proceeding with non-warranty repair or replacement. Warrantor shall have no liability to pay any costs for repairs performed by anyone other than Warrantor or its designee, unless in each instance Warrantor has given written approval for such repair. Warrantor shall not be responsible for any costs incurred for the removal or reinstallation of locksets covered by this Limited Warranty.

4. LIMITATION ON IMPLIED WARRANTIES.

ANY EXPRESS WARRANTY NOT PROVIDED IN THIS LIMITED WARRANTY, AND ANY REMEDY FOR BREACH OF CONTRACT THAT, BUT FOR THIS PROVISION, MIGHT ARISE BY IMPLICATION OR OPERATION OF LAW, IS EXCLUDED AND DISCLAIMED. THE IMPLIED WARRANTIES OF MERCHANTABILITY AND OF FITNESS FOR ANY PARTICULAR PURPOSE ARE EXPRESSLY LIMITED TO THE DURATION OF EACH EXPRESS WARRANTY PERIOD.

a. Should the locksets be considered a consumer product as may be covered by the Magnusson-Moss Federal Warranty Act, please be advised that some states do not allow limitations on how long an implied warranty lasts, so the above limitation may not apply to you.

5. CLAIM PROCEDURE.

To obtain performance of any obligation under this Limited Warranty, you must contact: ASSA ABLOY ACCENTRA™ Technical Product Support, 225 Episcopal Road, Berlin, CT 06037 USA, Tel 1-855-686-2204 option 1 Fax 1-800-338-0965.

- The Warrantor will only honor replacement with an identical or similar lockset or parts of it which are manufactured or distributed by the Warrantor.
- Customer service department hours are M-F 8:00am - 4:30pm, except holidays.

6. DISCLAIMER.

THERE ARE NO WARRANTIES THAT EXTEND BEYOND THE DESCRIPTION ON THE FACE OF THIS DOCUMENT. NO OTHER EXPRESS WARRANTY HAS BEEN MADE OR WILL BE MADE ON BEHALF OF THE WARRANTOR WITH RESPECT TO THE LOCKSET OR THE INSTALLATION, OPERATION, REPAIR OR REPLACEMENT OF THE LOCKSET. THE MAXIMUM LIABILITY OF ACCENTRA HEREUNDER IS LIMITED TO THE PURCHASE PRICE OF THE LOCKSET. UNDER NO CIRCUMSTANCES SHALL ACCENTRA BE LIABLE TO PURCHASER OR ANY OTHER PERSON FOR ANY SPECIAL OR CONSEQUENTIAL DAMAGES, WHETHER ARISING OUT OF TORT, BREACH OF WARRANTY, BREACH OF CONTRACT OR OTHERWISE.

- Should the locksets be considered a consumer product as may be covered by the Magnusson-Moss Federal Warranty Act, please be advised that (i) some states do not allow the exclusion or limitation of incidental or consequential damages, so the above limitation or exclusion may not apply to you, and (ii) this Limited Warranty gives you specific legal rights, and you may also have other rights which vary from state to state.
- Warrantor reserves the right to make changes in designs and specifications or to make additions or improvements on its products without notice and without incurring any obligation to incorporate them on products previously manufactured.

General Conditions

(a) Shipping; Acceptance; Risk of Loss; Security Interest. Any shipment date given by ACCENTRA is approximate and not a guarantee of delivery on the shipment date. Failure of a purchaser to inspect the Goods and notify ACCENTRA or any authorized distributor or factory representative in writing of such purchaser's rejection of any Goods upon completion of inspection within 24 hours after receipt of shipment, in each case setting forth the specific grounds for rejection, shall constitute unconditional acceptance of the Goods. Title to the Goods shall not pass until the full purchase price therefore has been paid in full. If after acceptance, the purchaser fails to pay the full purchase price as and when due, ACCENTRA shall be entitled to a writ of immediate possession to recover possession of the Goods. Risk of loss or damage to the Goods passes to the purchaser upon delivery of the Goods to the carrier regardless of who pays the shipping costs for such Goods. The purchaser hereby grants to ACCENTRA a continuing security interest in and to the Goods purchased from and/or financed by or through ACCENTRA to secure repayment of any debt or obligation owed to ACCENTRA by the purchaser.

(b) Force Majeure. Under no circumstances shall ACCENTRA be liable for failure or delay in delivery occasioned in whole or in part by fire, flood, explosion, casualty, accident, acts of God or natural catastrophe, war, riot, strike, lock-out or other labor dispute or industrial disturbance, embargo, law, regulation, ruling, order or requirement of any government or government agency or authority, court, tribunal or military authority, shortage or failure of, or ACCENTRA's inability to obtain, Goods, appropriate supplies, materials, equipment, transport or labor, or any other cause or circumstance beyond ACCENTRA's control, including delays due to a purchaser's acts omissions or rush circumstances. Under such circumstances, ACCENTRA may extend the date of delivery for a reasonable period of time after the period of the delay, apportion its products among its customers in such manner as it deems equitable and substitute for products which cannot be obtained within a

ASSA ABLOY ACCENTRA™

Terms and Conditions of Sale

reasonable period of time, and the purchaser shall not be relieved of accepting delivery of such products.

(c) **No Other Warranty.** The only warranty given in connection with any Goods sold by ACCENTRA is its Limited Warranty to the first purchaser-user provided in Section 3 of these Terms and Conditions of Sale, and no other representations or warranties of any kind shall be made or given by any distributor or other person in connection with the sale of the Goods.

Enforcement Policy

In the event ACCENTRA deems it necessary to collect any amount due it from any purchaser, the purchaser shall pay to ACCENTRA, upon demand, all costs and expenses of such collection or enforcement including, without limitation, reasonable attorneys' fees and all other costs of collection. In addition, ACCENTRA will assess a 1.5% finance charge per month (18% APR) on amounts not paid when due.

Returned Goods Policy

ACCENTRA will not accept returned Goods from purchasers for credit or exchange. Under limited exceptions the following conditions generally would apply:

- (a) Written consent to the return of the Goods must be obtained from the ACCENTRA Customer Service Manager prior to returning the Goods (at ACCENTRA's discretion);
- (b) Any returned Goods shall be accompanied by a completed Merchandise Return Authorization Form provided to the purchaser by ACCENTRA;
- (c) Shipping charges and insurance must be prepaid by the purchaser;
- (d) All returned Goods accepted by ACCENTRA shall be subject to a minimum charge of 45% of the original purchase price or the current price, whichever is lower, to cover the cost of testing and repackaging. Additional charges may be imposed if the returned Goods, in the opinion of ACCENTRA, require reconditioning; and
- (e) Any credit given will be based on the original purchase price or the current price for the returned Goods, whichever is the lower.

Terms and Conditions Contained in ACCENTRA Price Book

The Terms and Conditions contained in the ACCENTRA Price Book, as published from time to time, shall apply to all purchases of Goods. To the extent that any terms in any invoice conflict with the terms of the ACCENTRA Price Book, the terms of the ACCENTRA Price Book shall govern.

Dispute Resolution

All disputes, controversies, claims or differences which may arise between the parties out of or in relation to the purchase of Goods covered by any invoice or otherwise made by purchaser from ACCENTRA (including questions as to whether a matter is governed by this arbitration provision) shall be solely and exclusively settled by binding arbitration conducted in accordance with the American Arbitration Association (AAA) Rules. All hearings and proceedings regarding arbitration shall take place in Berlin, Connecticut. All disputes involving less than \$250,000 shall be heard by a single arbitrator, and all other disputes shall be heard by panel of three arbitrators. The arbitrators shall be selected in a manner as set forth by the AAA. Reasonable discovery shall be allowed. The costs and fees of the arbitration shall be allocated by the arbitrators. The award rendered by the arbitrators shall be final and binding upon the parties, and judgement may be entered and enforced in accordance with applicable law in any court having jurisdiction thereof. The resolution of the arbitration shall be kept confidential by the parties and the arbitrators. Nothing herein shall bar the right of either party to obtain injunctive relief against conduct that will cause irreparable loss or damages under rules of equity. The parties hereby consent to jurisdiction in any court in the State of Connecticut with respect to the enforcement of any arbitration award or injunctive or other judicial relief.

Changes or Cancellations

Any item additions, quantity changes or specification changes made to accepted orders will generate a new acknowledgment for the entire order and a new shipment date. All sales are final. Quantity reductions or cancellations are accepted only with prior written consent at least 2 weeks prior to the scheduled shipment date. Cancellations or reductions after 2 business days of acknowledgement may be subject to a 45% fee. We may without liability cancel any accepted order before shipment if our credit department does not approve your credit.

Programs

All support programs related to the business are only applicable to customers whose account is current and in good standing.

Customer Service

ASSA ABLOY ACCENTRA™, Customer Service Department
225 Episcopal Road, Berlin, CT 06037 USA
Tel 1-855-686-2204 | Fax 1-800-338-0965

Customer service department hours are between 8:00 am and 4:30 pm EST, Monday through Friday, except holidays.



Ordering Information

ACCENTRA
ASSA ABLOY

ORDER FORM
Order Entry Email*: orders.accentras@assaabloy.com
Order Entry Fax*: 1-800-338-0965

Customer PO: Your P.O. Number Here **1** Date: 00/00/00 **2**

Bill To: **3** Your Company Here Ship To: **4** Same
123 Street or Alternate Address Here
Your Town, USA

Notes: **5**

Email Address (for contact person): **6** Phone No. (with extension): **7**
8 **9** **10** **11** **12** **13** **14** **15**

ITEM	QTY	PART NUMBER** FUNCTION-STYLE-FINISH	DESCRIPTION** FUNCTION-STYLE-FINISH	ROSE STYLE	LATCH STYLE	STRIKE	KEYING	KEYWAY	PRICE
1.	2	YR620R DB BSP	820 Deadbolt Fl Rnd BSP	Flat Round	Std	Std	KA4 lines 11-12 & face set	SC1	00.00
2.									
3.									
4.									
5.									
6.									
7.									
8.									
9.									
10.									
11.									
12.									
13.									
14.									
15.									

Buyer Signature **16** Date Sales Representative **17** Date

06/30/18

1 Customer Purchase Order Number

Enter the purchase order number that your company has assigned for this order. No order will be processed without a purchase order number and written acknowledgement.

2 Order Date

Enter the date on which you are placing the order.

3 Bill To

Enter the billing name of the company and the full mailing address.

4 Ship To

Enter the company name and the full address to which the order should be shipped. If that information is exactly the same as the "Bill To" information, enter "Same" on the lines provided.

5 Special Instructions

- Enter any special shipping, packing, product, keying, or delivery requests in this area.
- Enter job name if applicable.
- For warehouse orders (non job orders) full case quantities should be ordered.

UL RATING REQUIREMENTS:



Enter when UL is required.

See price book pages for listing. Underwriters Laboratories requires that the Fire Shield packed with each UL listed products, UL listed latches and the correct strike to be used.

6 Email Address and Phone Number

Indicate an email address and phone number (with extension) to ensure ASSA ABLOY ACCENTRA™ Locks is able to respond with questions regarding the order.

7 Quantity (Units Only)

Standard Case Quantities

	Heritage Collection Grade 2	Heritage Collection Grade 3
Dummy	12	12
Knobs	24	24
Levers	12	12
Deadbolts	12	12
Combosets	12	12
Interconnected Mechanical	4	
Handlesets	6	6
Handlesets Interior Pack	6	6

8 Part Number

FUNCTION-STYLE-FINISH

FUNCTION: Function numbers and descriptions are noted with each series throughout this ACCENTRA Price Book.

STYLE: Indicate by using the two letter designation of the names, listed on price pages.

Ordering Information

FINISH: Indicate by using the BHMA designation of the names, listed on price pages.

BHMA	Description
605	Polished Brass
609	Antique Brass
613E	Dark Oxidized Satin Bronze-equivalent
10BP	Oil Rubbed Bronze Permanent
619	Satin Nickel
620	Antique Nickel
625	Polished Chrome
626	Satin Chrome
BSP	Black Suede
GM	Gun Metal

Split Finishes: Print as stated in current price book

9 Description

FUNCTION-STYLE-FINISH-PACKAGING-HANDING

FUNCTION: Function numbers and descriptions are noted with each series throughout this Price Book.

DESIGN: Indicate by using the two letter designation of the names, listed on price pages.

FINISH CODES: see above.

PACKAGING: All locks are shipped Box Packed as standard unless otherwise specified. SP: Box Packed (Standard Packed)

BP: Bulk Pack – Lock trim individually boxed and packed 24 per case. Latches, strikes, screws packed separately.

HANDING: The hand of a door is always determined by facing the outside of a door. See diagram on pages 10, 20, 32 for further details.

LH: If the hinge is on the left side of the door, then the door is left-handed.

RH: If the hinge is on the right side of the door, then the door is right-handed.

10 Decorative Rose Style

Specify decorative rose style selection. Standard rose ships unless specified.

11 Latch Options

Specify 2-3/8", 2-3/4", or Adjustable along with latch face type.

See Examples:

SC (Square Corner)

RC (Round Corner)

DI (Drive-In)

ADJ-SC (Adjustable Square Corner)

See pages 27, and 37 for more details.

12 Strike Options

Specify strike type. See page 42 for more details.

13 Specifying Keying

Keying requirements must be specified at time of order.

KD: Keyed Different

KA: Keyed Alike

MK: Master Keyed* (A single master key operates all locks within the system.)

BK: Builder Key* (Builder key operates all locksets within a system. Use of homeowner's key cancels the builder key.)

BMK: Builder Keyed and Master Keyed* (Builder key and master key operates all locksets within a system. Use of tenants key cancels the builder key.)

K-T-P: Keyed To Pass (For apartment vestibules or laundry rooms. All tenant keys will operate.)

GMK: Grand Master Keyed* (More than 1 master key system operated by a single master key.)

BGMK: Builder Keyed and Grand Master Keyed* (Combination of BK and GMK.) *Builder and/or master keys are sent certified mail to the "Bill To" address, referencing the purchase order number and the original order number. All Master Keyed orders shipped with three (3) master keys at no extra charge. All Builder Keyed orders are shipped with ten (10) builder keys at no extra charge.

14 Keyway / Key System Specifications

KEYWAY: All locks will be shipped with our Heritage Collection Grade 3 KW 5-Pin cylinder or Heritage Collection Grade 2 6-Pin cylinder as standard depending upon the locks ordered. If SC keyway is specified it will ship as 5-pin standard. Para keyway will ship as 6-pin standard. See the available options sections in this Price Book.

KEY SYSTEMS: Note the specific key system to be used if any. This is particularly important if the order is an extension of an existing system.

15 Price

Enter the price. NOTE: Price may be adjusted if required to correspond to published pricelist.

Ordering Information

16 Buyer Signature

No order will be processed without an authorized signature.

17 ASSA ABLOY ACCENTRA™ Company Representative

If the order is written by someone other than the authorized buyer, the full name of the person placing the order.

Submit The Order

FAXING ORDERS

Fax number for Factory Direct Heritage Collection Grade 2 and Grade 3 orders:

1-800-338-0965

EMAILING ORDERS

Email all orders to:

orders.AccentraRes@assaabloy.com

Heritage Collection Grade 2 Interconnected Mechanical Locksets

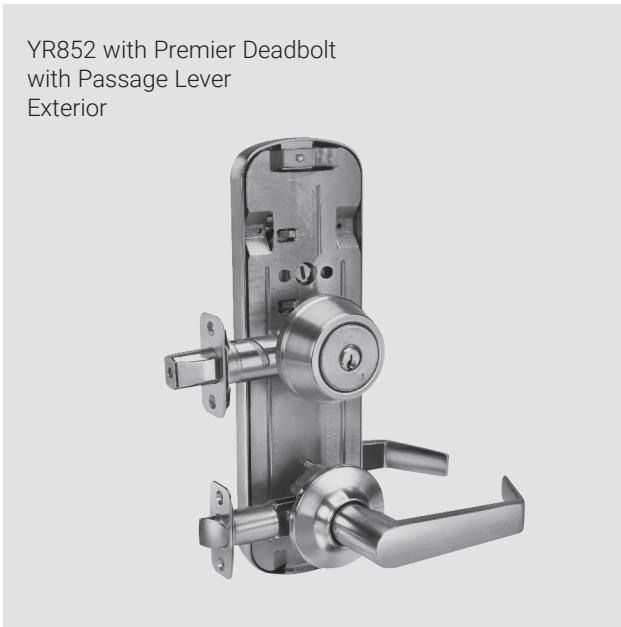

Adjustable 4" or 5.5"





The Heritage Collection Grade 2 Interconnected Mechanical Locksets offer flexible, convenient and stylish security for new or retrofit multi-family applications. The center to center dimension is field-adjustable and installs into most standard door preps. From the inside, latchbolt and deadbolt retract simultaneously for easy egress and the thumbturn quickly secures the opening. Available in two functions with 14 levers in 6 finishes, the Interconnected Mechanical locksets are sure to complement any décor.

Heritage Collection Grade 2 Interconnected Mechanical Locksets

FUNCTIONS

FUNCTION	NO.	DESCRIPTION
	YR852	PASSAGE: Single point lock. Latchbolt is operated by either lever at all times. Deadbolt activated by key on outside; inside by T-turn. Interior lever retracts latch and deadbolt simultaneously.
	YR853	PRIVACY WITH DEADBOLT INDICATOR: Single point lock. Latchbolt is operated by either lever at all times. Deadbolt activated by emergency key on outside; inside by T-turn. Occupancy indicator displays "In Use" when deadbolt thrown or "Vacant" when deadbolt retracted. Interior lever retracts latch and deadbolt simultaneously.

PRODUCT SPECIFICATIONS

Door Specs	2 1/8" Face Bore, 1" Edge Bore, 4" or 5 1/2" Center to Center
Backset	2 3/8" or 2 3/4"
Door Thickness	1 3/8" to 1 3/4"
Cylinder	KW-1 Compatible standard, other cylinders/keyways available to order
Keying	KD (Keyed Different) standard, master keying available to order Other Keying options see page 43
Latch Faceplate	1" W x 2 1/4" H; Round Corner standard, Square Corner available to order
Strike	2 1/4" RC Full Lip & 1 1/8" x 2 3/4" RC Universal standard, Other strikes Available to order.
Certified ANSI/BHMA	A156.12, Grade 2 
UL/cUL	Listed for 90 minute fire doors 

DIMENSIONS A B C D WIDTH

Based on Woodland Lever

PASSAGE

Lever	10 8/16" 12 1/8"	2 5/8"	2 1/2"	4" 5 1/2"	2 13/16"
--------------	---------------------	--------	--------	--------------	----------

ENTRY

Lever	10 8/16" 12 1/8"	2 5/8"	2 1/2"	4" 5 1/2"	2 13/16"
--------------	---------------------	--------	--------	--------------	----------

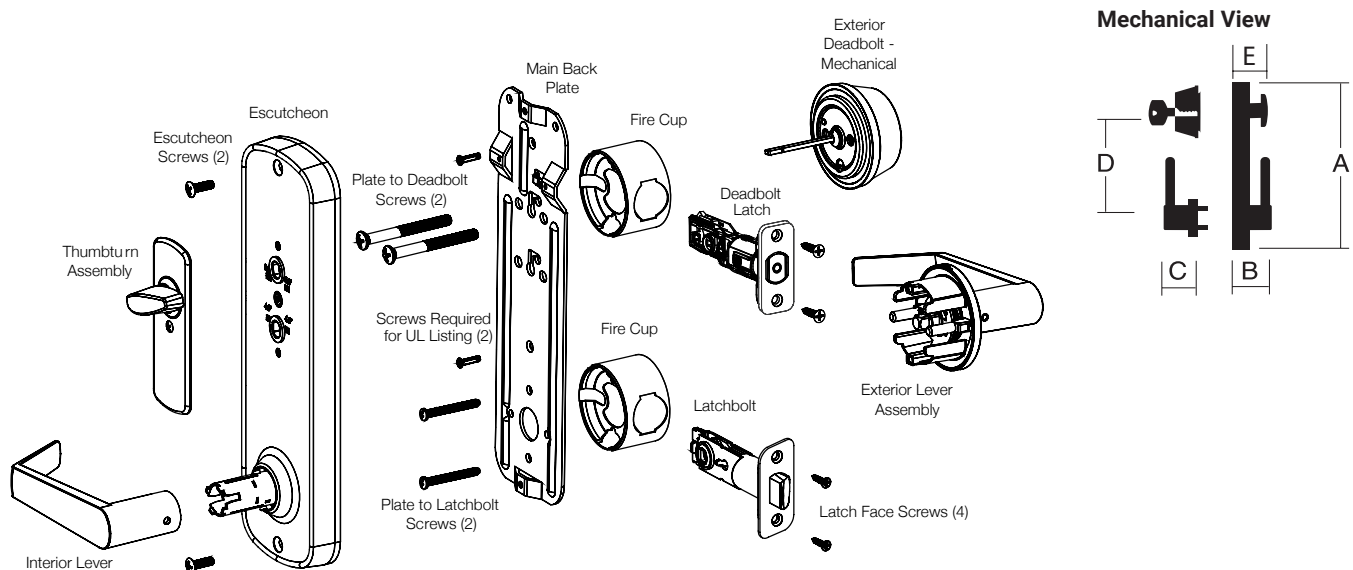

Price List

HERITAGE COLLECTION GRADE 2

LIST PRICE

Interconnected

Available lever styles shown below.
Premier Deadbolt - Standard KW, SC, Para
D200 Deadbolt - GA, SFIC, Others
90 Min UL Rating Standard

	DESIGN	FUNCTION NO BHMA	605	619	BSP Black Suede	626	10BE 613E	10BP
YR852 Single Locking All Levers	Interconnect	852	260.00	260.00	260.00	260.00	280.80	280.80
YR853 Privacy with Indicator All Levers	Interconnect	853	260.00	260.00	260.00	260.00	280.80	280.80

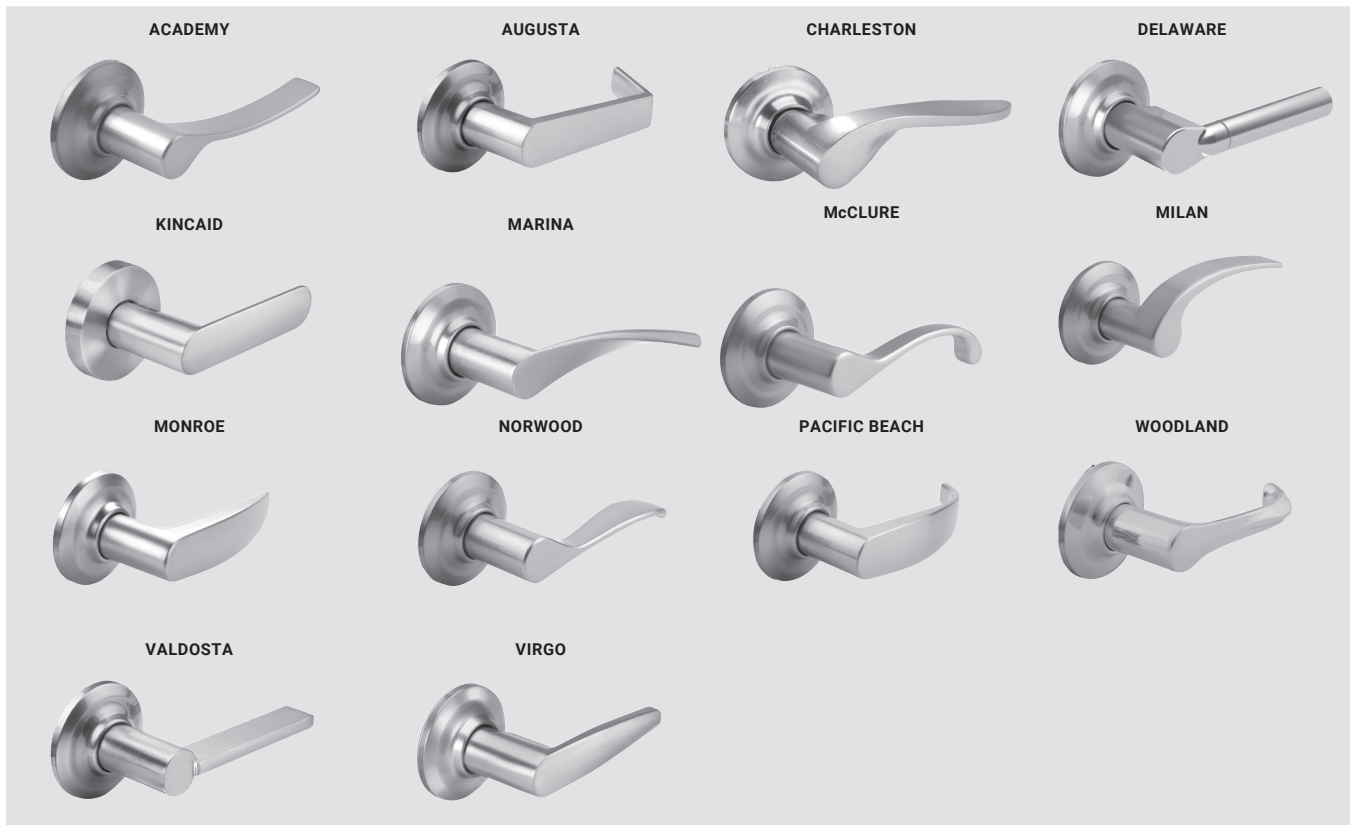

Price List

INTERCONNECTED PASSAGE LEVER PAIRS

Design	Part #	626	619
Academy (Passage Lever Pair)	YR05D67	37.40	37.40
Augusta (Passage Lever Pair)	YR05D66		
Delaware (Passage Lever Pair)	YR05D6D	37.40	37.40
Kincaid (Passage Lever Pair)	YR05D6K		
Marina (Passage Lever Pair)	YR05D64	37.40	37.40
McClure (Passage Lever Pair)	YR05D65		
Milan (Passage Lever Pair)	YR05D63	37.40	37.40
Monroe (Passage Lever Pair)	YR05D6W		
Norwood (Passage Lever Pair)	YR05D68	37.40	37.40
Pacific Beach (Passage Lever Pair)	YR05D62		
Valdosta (Passage Lever Pair)	YR05D6V	37.40	37.40
Virgo (Passage Lever Pair)	YR05D61		
Woodland (Passage Lever Pair)	YR05D69	37.40	37.40

OPTIONS

Less Cylinder (LC)	\$0.00 No deductions	
SFIC (LC only)	\$0.00 No deductions	Lock SFICLC only. A600 or K600 available, should be listed as a separate line item. To order specify SFIC.
LFIC (LC only)	No deductions	Lock LFICLC only. 1210, 5210 or K800 core available, should be listed as a separate line item. To order specify YR852 x LFIC.
Arrow Keyway	\$0.00 No adder	To order specify "AR" keyway.
Para Keyway	\$0.00 No adder	
GA Keyway (Only)	\$0.00 No adder	Extend leadtime for BK, MK, GMK, etc.
Other Commercial keyways and Cylinder formats	\$0.00 No deductions	1. Specify less core when ordering through ASSA ABLOY ACCENTRA™ Residential 2. Order cylinder through ASSA ABLOY ACCENTRA™ Commercial.
KW1 cylinder separately 6 pin	\$11.20	See page 44 for cylinder options and part numbers.
Schlage C separately 6-pin	\$15.90	See page 44 for cylinder options and part numbers.
ACCENTRA Para separately 6 pin	\$15.90	See page 44 for cylinder options and part numbers.
1803 Cylinder separately	Includes GB - GH	Order through ASSA ABLOY ACCENTRA™ Commercial DB = 1803-134S and Lever = 1803-54K
Arrow cylinders separately	See Arrow Price Book	DB = 692C x 6 pin and Lever = 100YC x 6 pin

Latch Price List

LOCKSET LATCHES

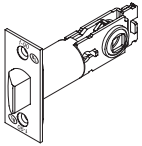
PLAIN SPRING LATCHES	BACKSET	FRONT WIDTH	THROW	LATCH DIAMETER**	CORNER SPECS	MODEL NO	LIST PRICE
		2-3/8" (60mm)	1" (25mm)	1/2" (13mm)	7/8" (22mm)	Radius	YR01802*U
	2-3/8" (60mm)	1" (25mm)	1/2" (13mm)	7/8" (22mm)	Square	YR01804*U	13.20
	2-3/4" (70mm)	1" (25mm)	1/2" (13mm)	7/8" (22mm)	Radius	YR01806*U	13.20
	2-3/4" (70mm)	1" (25mm)	1/2" (13mm)	7/8" (22mm)	Square	YR01808*U	13.20

*Specify finish when ordering.

MECHANICAL DEADBOLT LATCHES

For use with ASSA ABLOY ACCENTRA™ PARA, Kwikset and Schlage C keyway cylinders (82 Deadbolt)

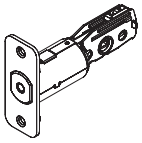
	BACKSET	FRONT WIDTH	THROW	CORNER SPECS	MODEL NO	LIST PRICE
	Adjustable^	1" (25mm)	1" (25mm)	Square	YR01D44*U	15.20
	Adjustable^	1" (25mm)	1" (25mm)	Radius	YR01D41*U	15.20

For use with LFIC, SFIC, Arrow and ASSA ABLOY ACCENTRA™ Commercial GA Keyway cylinders. (D200 Deadbolt)

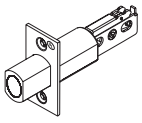
	BACKSET	FRONT WIDTH	THROW	CORNER SPECS	MODEL NO	LIST PRICE
	2-3/8" Fixed	1" (25mm)	1" (25mm)	Square	D38*	**
	2-3/8" Fixed	1" (25mm)	1" (25mm)	Radius	D38R*	**
	2-3/4" Fixed	1" (25mm)	1" (25mm)	Square	D34*	**
	2-3/4" Fixed	1" (25mm)	1" (25mm)	Radius	D34R*	**

*Specify finish when ordering.

FIXED CORE CYLINDERS

LOCK TYPE	KEYWAY	DESCRIPTION	MODEL NUMBER		NUMBER OF PINS	LIST PRICE
			LOCKSET	DEADBOLT		
Mechanical	Kwikset®	Standard cylinder. Available 1-bitted, KA, KD (std), MK, BK	YR06D013 (605)	YR06D103ICN (605)	6	10.60
			YR06D016 (626)	YR06D106ICN (626)		
	ASSA ABLOY ACCENTRA™ PARA	Optional cylinder. Available 0-bitted, KD, KA, MK, BK	YR06Y303 (605)	YR06Y413ICN (605)	6	15.20
			YR06Y306 (626)	YR06Y416ICN (626)		
	ACCENTRA GA	Optional cylinder. Available 0-bitted, KD, KA, MK, CMK extend leadtime for BK, MK, GMK, etc.	1803-54K	1803-134S	6	**
	Arrow AR	Optional cylinder. Available KA, KD	100YC	692C	6	**
Schlage® C	Optional cylinder. Available 0-bitted, KD, KA, MK, BK	YR068D01 (605) YR068D05 (626)	YR068D02ICN (605) YR068D06ICN (626)	6	15.20	

605 finish cylinders used with 605, 613E and 10BP finish locks. 626 finish cylinders used with 619, 626, BSP finish locks. Specify finish and keying when ordering.

Specify finish and keying when ordering.

**Note: Other ASSA ABLOY ACCENTRA™ Commercial keyways and cylinder mechanisms available separately. Contact customer service for availability. Specify finish and keying when ordering.

INTERCHANGEABLE CORE

Small Format – Small format interchangeable core is available. To order, specify "x SFIC-LC" for cylinder. i.e. AU x YR852 x SFIC-LC x 4" x 626. All units will be provided less core. Model number A600 or K600 cores can be ordered separately through ASSA ABLOY ACCENTRA™ Commercial.

Large Format – ASSA ABLOY ACCENTRA™ Commercial large format interchangeable core is available for passage function. To order, specify "x LFIC-LC" for cylinder. i.e. AU x YR852 x LFIC-LC x 4" x 626. All units will be provided less 6-pin core only. LFIC cores can be ordered separately through ASSA ABLOY ACCENTRA™ Commercial.

Navis Paddle



Navis



The Navis Paddle redefines the landscape of residential mechanical hardware with push to open products designed to fit seamlessly into your home. The Navis Paddle makes door opening versatile and convenient for any member of the household. A door can be easily pushed open with a hip or elbow when carrying an armful of groceries or a load of laundry – its two-way push/pull operation makes it ideal for laundry rooms, garage entries, basements, bedrooms and more. The ADA-compliant handle is also accessible for children, the elderly and the disabled.

- Hands full? No problem. Just push or pull! The Navis Paddle redefines the way we open and close doors today. Instead of rotating, just push or pull - with the palm of your hand, elbow or hip for faster, easier access.
- Two-way push/pull operation makes Navis ideal for laundry rooms, garage entries, basements, bedrooms and more.
- Fits standard doors. Works with both inswing and outswing doors, and can be handed for left or right swing.

Navis Paddle

STYLES			PRODUCT SPECIFICATIONS	
STYLE	NO.	DESCRIPTION	Face Bore	2 1/8" Face Bore
	11	PASSAGE: Latchbolt is operated by either lever at all times. (nonhanded)	Edge Bore	1"
	21	PRIVACY: Latchbolt is operated by either paddle except when inside is locked by push button. Push button is released by pushing paddle on inside or with tool on outside.	Latch	Available in 2 3/8" or 2 3/4"
	81	DUMMY: For doors where only pull is required.	Door Thickness	1 3/8" to 1 3/4"
			Strike	2 1/4" Full Lip RC (Round Corner)

Standard Case Quantities - Enter the exact number of individual units required. As an example: If there are 12 units in a case and you require 1 case, enter 12 in the "quantity" space. See below for an example of standard case quantities.

STANDARD CASE QUANTITIES (NAVIS PADDLE)	
	Box Pack(SP)
Levers	12

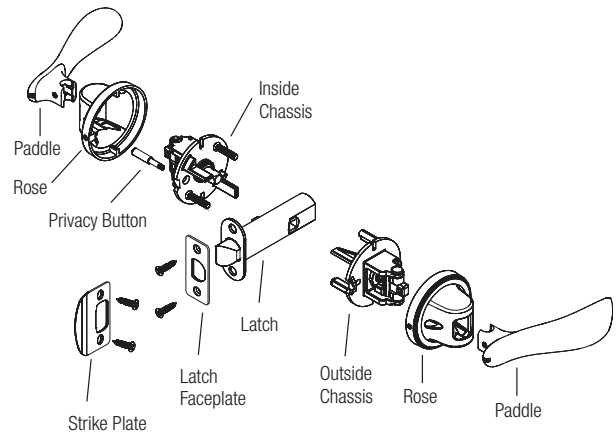
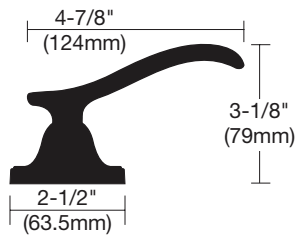

DESIGN	FUNCTION	NO	605	625	626	613E	US10BP	609	619	620	GM	BSP
											Gun Metal	Black Suede
Navis (NV)	Dummy	81	49.90	N/A	49.90	N/A	49.90	N/A	49.90	N/A	N/A	49.90
	Passage	11	91.50	N/A	91.50	N/A	91.50	N/A	91.50	N/A	N/A	91.50
	Privacy	21	96.70	N/A	96.70	N/A	96.70	N/A	96.70	N/A	N/A	96.70

NAVIS PADDLE COMPONENTS

Latch Face Plate RC	03	YR01P213	3.10	Privacy Pin	BSP	YR08P00S	3.10
Latch Face Plate RC	15	YR01P21N	3.10	Privacy Pin	15	YR08P00N	3.10
Latch Face Plate RC	10BP/BSP	YR01P21B	3.10	Privacy Pin	03	YR08P003	3.10
Latch Passage 2-3/8		YR01P106	14.60	Privacy Pin	10BP	YR08P00K	3.10
Latch Passage 2-3/4		YR01P336	14.60	Screw Pack	10BP/BSP	YR07P0B	4.20
Latch Privacy 2-3/8		YR01P306	14.60	Screw Pack	15	YR07P0N	4.20
Latch Privacy 2-3/4		YR01P316	14.60	Screw Pack	03	YR07P03	4.20

Heritage Collection Grade 2 Knobs

Bridgeport



Dartmouth



Cambridge

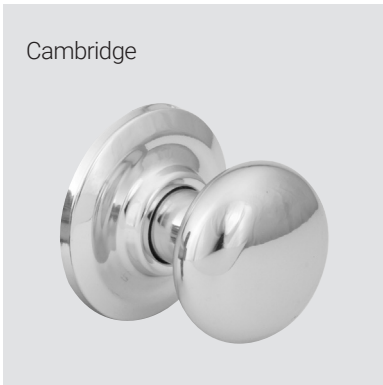



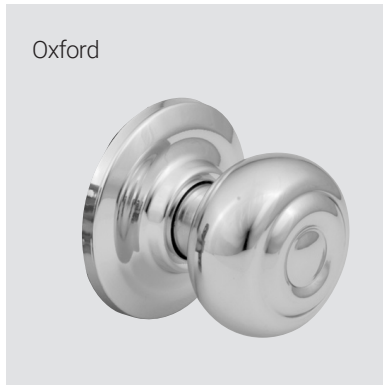





Oxford



The Heritage Collection Grade 2 continues a legacy of distinctive design, high manufacturing standards and demanding performance. The Heritage Collection Grade 2 leverages years of engineering refinement with artful execution to offer a series of ANSI Grade 2 superior light commercial quality locks that will beautifully serve any home for generations. They offer superior functionality such as push-button locking and removable knobs for simple re-keying.

Heritage Collection Grade 2 Knobs

FUNCTIONS

FUNCTION	NO.	DESCRIPTION
	80	DUMMY: For doors where only pull is required.
	10	PASSAGE: Latchbolt is operated by either knob at all times.
	60	ONE SIDED W/PLATE: Latchbolt is operated by knob on one side only.
	20	PRIVACY: Latchbolt is operated by either knob except when inside knob is locked by push button. Push button is released by special emergency key on outside or by turning inside knob.
	26	BATHROOM: Same function as 20 privacy with US26 finish on interior knob.
	70	ENTRY: Guarded latchbolt operated from outside by key; inside by knob. Push button locks outside knob. Outside knob unlocks by key or by turning inside knob.
	75	CLASSROOM: Guarded latchbolt operated by either knob except when outside knob is locked by out side key. Inside knob is always free.
	78	STOREROOM: Guarded latchbolt operated from outside knob by key; inside by knob. Outside knob fixed until cylinder is unlocked by key. Key captured until cylinder is locked. Inside knob is always free.

DIMENSIONS	A	B	C
Bridgeport	2 ⁹ / ₁₆ "	2 ⁹ / ₁₆ "	2"
Oxford	2 ⁹ / ₁₆ "	2 ¹ / ₄ "	2 ¹ / ₈ "
Cambridge	2 ⁹ / ₁₆ "	2 ¹ / ₄ "	2 ⁵ / ₆₄ "
Dartmouth	2 ⁹ / ₁₆ "	2 ³ / ₈ "	2 ¹ / ₂ "

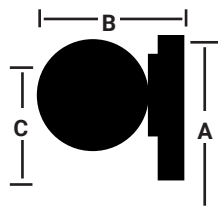

PRODUCT SPECIFICATIONS

Door Specs	2 ¹ / ₈ " Face Bore, 1" Edge Bore, 2 ³ / ₈ " or 2 ³ / ₄ " Backset Latch Face 1" x 2 ¹ / ₄ " RC (Round corner; Square corner optional)
Latch	Adjustable 2 ³ / ₈ " to 2 ³ / ₄ " RC (Round Corner)
Door Thickness	1 ³ / ₈ " to 1 ³ / ₄ "
Cylinder	6 Pin KW-1 Standard (SC-1 Optional)
Keying	KA3 (Keyed Alike)
Faceplate	1" W x 2 ¹ / ₄ " H RC (Round Corner)
Strike	2 ¹ / ₄ " Full Lip RC (Round Corner)
Certified ANSI/BHMA	A156.39 Grade A 

Standard Case Quantities - Enter the exact number of individual units required. As an example: If there are 24 units in a case and you require 1 case, enter 24 in the "quantity" space. See below for an example of standard case quantities.

STANDARD CASE QUANTITIES (Heritage Collection Grade 2)

	Box Pack(SP)
Dummy	12
Knobs	24
Levers	12
Deadbolts	12
Combo Sets	12

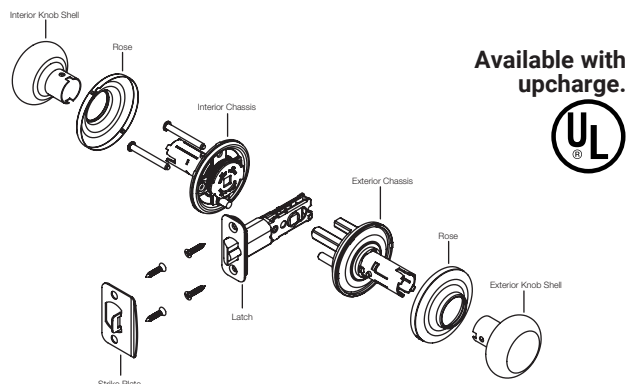

Price List

Heritage Collection Grade 2

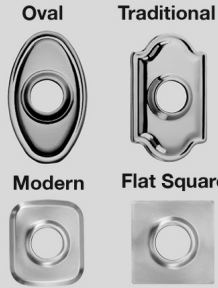

Oval 2-9/16" W x 4-7/32" H
Center Hole: Knob 15/16" – Lever 1-1/32"

Traditional 2-9/16" W x 4-7/32" H
Center Hole: Knob 15/16" – Lever 1-1/32"

Modern 2-9/16" W x 3" H
Center Hole: 1-1/32"

Flat Square 2-9/16" W x 2-9/16" H
Center Hole: 1-1/32"

Pair with all Heritage Collection Grade 2 knob styles.

Rosette Availability	605	10BP	619	BSP	625	626	List Upcharge Full Lockset	Dummy
Oval	•	•	•				20.80	10.40
Traditional	•	•	•				20.80	10.40
Modern		•	•	•			16.60	8.30
Flat Square		•	•	•	•	•	16.60	8.30

Note: Decorative rosettes ship separate as kit.

LIST PRICE Knobs

Featuring Push Button Locking with Free Interiors

DESIGN	FUNCTION	NO	605	626	609	619	GM	BSP	625	620	613E	10BP
							Gun Metal	Black Suede				
Bridgeport (BP)	Dummy	80	15.10	15.10	N/A	15.10	N/A	N/A	16.10	N/A	N/A	N/A
	One Sided w/plate	60	38.10	38.10	N/A	38.10	N/A	N/A	40.10	N/A	N/A	N/A
	Passage	10	38.10	38.10	N/A	38.10	N/A	N/A	40.10	N/A	N/A	N/A
	Privacy	20	43.70	43.70	N/A	43.70	N/A	N/A	45.80	N/A	N/A	N/A
	Bath*	26	46.80	46.80	N/A	46.80	N/A	N/A	48.90	N/A	N/A	N/A
	Entry	70	73.00	73.00	N/A	73.00	N/A	N/A	75.10	N/A	N/A	N/A
	Classroom	75	73.00	73.00	N/A	73.00	N/A	N/A	75.10	N/A	N/A	N/A
	Storeroom	78	73.00	73.00	N/A	73.00	N/A	N/A	75.10	N/A	N/A	N/A
Cambridge (CB)	Dummy	80	15.10	15.10	15.10	15.10	15.10	15.10	16.10	16.10	16.10	16.10
	One Sided w/plate	60	38.10	38.10	38.10	38.10	38.10	38.10	40.10	40.10	40.10	40.10
	Passage	10	38.10	38.10	38.10	38.10	38.10	38.10	40.10	40.10	40.10	40.10
	Privacy	20	43.70	43.70	43.70	43.70	43.70	43.70	45.80	45.80	45.80	45.80
	Bath*	26	46.80	46.80	46.80	46.80	46.80	46.80	N/A	48.90	48.90	48.90
	Entry	70	73.00	73.00	73.00	73.00	73.00	73.00	75.10	75.10	75.10	75.10
	Classroom	75	73.00	73.00	73.00	73.00	73.00	73.00	75.10	75.10	75.10	75.10
	Storeroom	78	73.00	73.00	73.00	73.00	73.00	73.00	75.10	75.10	75.10	75.10
Dartmouth (DM)	Dummy	80	26.00	N/A	N/A	26.00	26.00	26.00	N/A	N/A	27.00	27.00
	One Sided w/plate	60	59.40	N/A	N/A	59.40	59.40	59.40	N/A	N/A	61.50	61.50
	Passage	10	59.40	N/A	N/A	59.40	59.40	59.40	N/A	N/A	61.50	61.50
	Privacy	20	64.10	N/A	N/A	64.10	64.10	64.10	N/A	N/A	66.10	66.10
	Entry	70	86.10	N/A	N/A	86.10	86.10	86.10	N/A	N/A	88.20	88.20
	Classroom	75	86.10	N/A	N/A	86.10	86.10	86.10	N/A	N/A	88.20	88.20
	Storeroom	78	86.10	N/A	N/A	86.10	86.10	86.10	N/A	N/A	88.20	88.20
	Oxford (XF)	Dummy	80	15.10	N/A	15.10	15.10	N/A	N/A	N/A	N/A	N/A
One Sided w/plate		60	38.10	N/A	38.10	38.10	N/A	N/A	N/A	N/A	N/A	40.10
Passage		10	38.10	N/A	38.10	38.10	N/A	N/A	N/A	N/A	N/A	40.10
Privacy		20	43.70	N/A	43.70	43.70	N/A	N/A	N/A	N/A	N/A	45.80
Entry		70	73.00	N/A	73.00	73.00	N/A	N/A	N/A	N/A	N/A	75.10
Classroom		75	73.00	N/A	73.00	73.00	N/A	N/A	N/A	N/A	N/A	75.10
Storeroom		78	73.00	N/A	73.00	73.00	N/A	N/A	N/A	N/A	N/A	75.10

AVAILABLE OPTIONS

LIST PRICE UPCHARGE

Rosettes - Traditional, Oval	Full Lockset	20.80
Rosettes - Traditional, Oval	Dummy	10.40
Rosettes - Flat Square & Modern	Full Lockset	16.60
Rosettes - Flat Square & Modern	Dummy	8.30
Accessory Stemmed Dummy Plate	073003	4.70
(allows 2 dummies to be installed on a through bored door)		
UL 90 Minute listing		6.20
UL 90 Minute listing	Combo Sets	12.50

AVAILABLE OPTIONS

LIST PRICE UPCHARGE

Page 18	Heritage Collection Grade 2 Series Latches	NC when specified
Page 42	T-Strikes	1.50
Page 42	ANSI 4 7/8" Strike	7.10
Page 42	Other Lockset Strikes	NC when specified
Page 43	Additional keying options	
	Extension Kit 2 to 2 1/4" Heritage Collection Grade 2 Knobs/Levers (Passage) # YR076100	5.20 (specify finish)



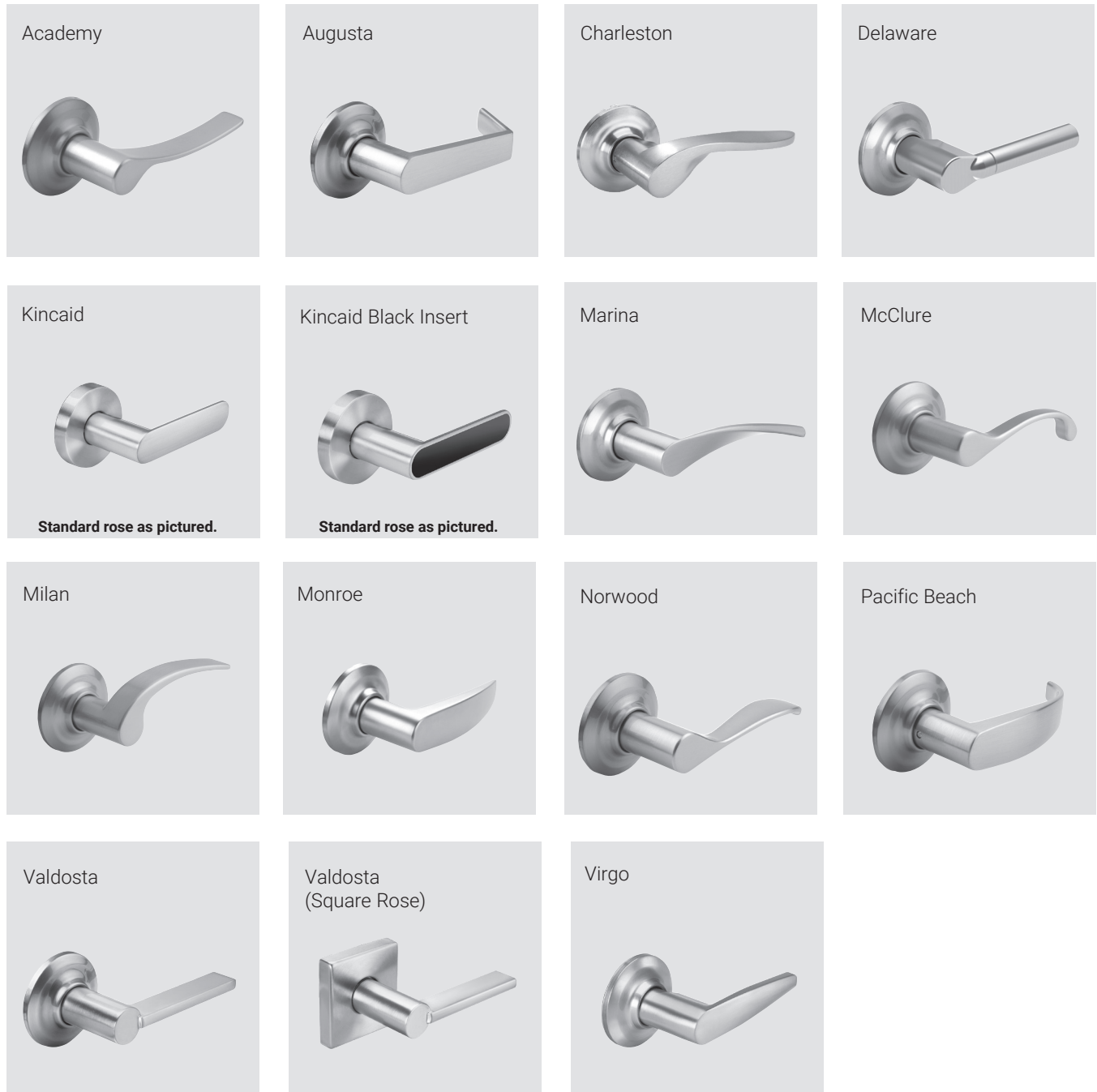







Heritage Collection Grade 2 Levers



Heritage Collection Grade 2 levers offer a range of designs with sculptured roses and delicately crafted curves. The “non-handed” design and strength of the interior sub-assemblies allow for quick and easy installation and years of secure operation. All products in this series are ANSI Grade 2 superior light commercial quality.

Heritage Collection Grade 2 Levers

FUNCTIONS

FUNCTION	NO.	DESCRIPTION
	81	DUMMY: For doors where only pull is required. (handing required)
	11	PASSAGE: Latchbolt is operated by either lever at all times. (non-handed)
	61	ONE SIDED W/PLATE: Latchbolt is operated by lever on one side only. (handing required)
	21	PRIVACY: Latchbolt is operated by either lever except when inside lever is locked by push button. Push button is released by coin release slot on outside or by turning inside lever. (non-handed)
	22	BATHROOM: Same function as 21 privacy with US26 finish on interior lever. (handing required)
	71	ENTRY (LEVER/LEVER): Guarded latchbolt operated from outside by key; inside by lever. Push button locks outside lever. Outside lever unlocks by key or by turning inside lever. (nonhanded)
	73	ENTRY (LEVER/LEVER): Guarded latchbolt operated from outside lever by key. Inside by lever. Turn button locks outside lever. Outside lever unlocks by key or turning inside turn button. (non-handed)
	74LC	ENTRY (Lever/Lever): Guarded latchbolt with SFIC cylinder operated from outside lever by key. Inside by lever. Turn button locks outside lever. Outside lever unlocks by key or turning inside turn button. (non-handed)
	76	CLASSROOM: Guarded latchbolt operated by either lever except when outside lever is locked by outside key. Inside lever is always free. (handing required)
	79	STOREROOM: ADA Guarded latchbolt operated from outside lever by key; inside by lever. Outside lever fixed until cylinder is unlocked by key. Key captured until cylinder is locked. Inside lever is always free. (handing required)

PRODUCT SPECIFICATIONS

Door Specs	2 ¹ / ₈ " Face Bore, 1" Edge Bore, 2 ³ / ₈ " or 2 ³ / ₄ " Backset Latch Face 1" x 2 ¹ / ₄ " RC (Round corner; Square corner optional)
Latch	Adjustable 2 ³ / ₈ " or 2 ³ / ₄ " RC (Round Corner)
Door Thickness	1 ³ / ₈ " to 1 ³ / ₄ "
Cylinder	6 Pin KW-1 Standard (SC-1 Optional)
Keying	KA3 (Keyed Alike)
Faceplate	1" W x 2 ¹ / ₄ " H RC (Round Corner)
Strike	2 ¹ / ₄ " Full Lip RC (Round Corner)
Certified ANSI/BHMA	A156.2 Series 4000 Grade 2 A156.39 Grade A 

DIMENSIONS	A	B	C
Academy	2 ⁹ / ₁₆ "	2 ⁷ / ₁₆ "	4 ¹⁹ / ₆₄ "
Augusta	2 ⁹ / ₁₆ "	2 ¹ / ₂ "	4 ³ / ₄ "
Charleston	2 ⁹ / ₁₆ "	2 ¹ / ₂ "	5 ³ / ₈ "
Delaware	2 ⁹ / ₁₆ "	2 ³ / ₄ "	4 ⁵ / ₈ "
Kincaid	2 ⁹ / ₁₆ "	2 ⁷ / ₁₆ "	4 ¹ / ₂ "
Kincaid Black Insert	2 ⁹ / ₁₆ "	2 ⁷ / ₁₆ "	4 ¹ / ₂ "
Marina	2 ⁹ / ₁₆ "	3 ⁵ / ₁₆ "	4 ⁷ / ₈ "
McClure	2 ⁹ / ₁₆ "	2 ⁷ / ₁₆ "	4 ³ / ₁₆ "
Milan	2 ⁹ / ₁₆ "	2 ⁷ / ₁₆ "	4 ¹ / ₁₆ "
Monroe	2 ⁹ / ₁₆ "	2 ⁷ / ₁₆ "	4 ⁵ / ₈ "
Norwood	2 ⁹ / ₁₆ "	2 ¹ / ₂ "	4 ⁷ / ₃₂ "
Pacific Beach	2 ⁹ / ₁₆ "	2 ⁷ / ₁₆ "	4 ³ / ₄ "
Valdosta	2 ⁹ / ₁₆ "	2 ¹ / ₂ "	4 ⁵ / ₈ "
Virgo	2 ⁹ / ₁₆ "	2 ⁹ / ₁₆ "	4 ¹ / ₂ "

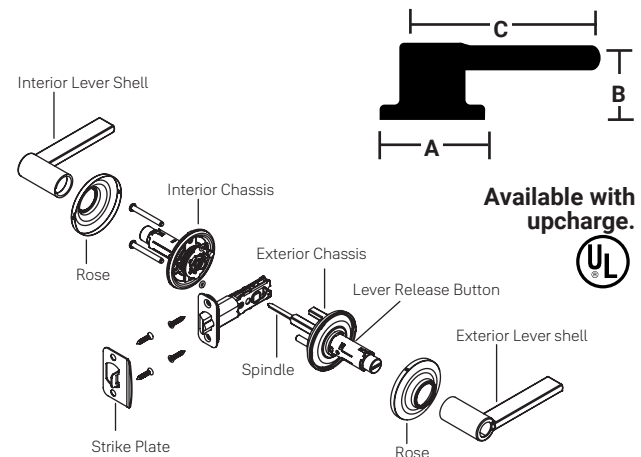

Standard Case Quantities - Enter the exact number of individual units required. As an example: If there are 24 units in a case and you require 1 case, enter 24 in the "quantity" space. See below for an example of standard case quantities.

STANDARD CASE QUANTITIES (Heritage Collection Grade 2)	BOX PACK(SP)
Dummy	12
Knobs	24
Levers	12
Deadbolts	12
Combo Sets	12

Heritage Collection Grade 2 Levers

Decorative Rosettes

Oval 2-9/16" W x 4-7/32" H
Center Hole: Knob 15/16" – Lever 1-1/32"

Traditional 2-9/16" W x 4-7/32" H
Center Hole: Knob 15/16" – Lever 1-1/32"

Modern 2-9/16" W x 3" H
Center Hole: 1-1/32"

Flat Round 2-9/16" Dia
Center Hole: 1-1/32"

Flat Square 2-9/16" W x 2-9/16" H
Center Hole: 1-1/32"

Oval Traditional Modern



Flat Round Flat Square



Pair with all Heritage Collection Grade 2 lever styles.

Rosette Availability	605	10BP	619	BSP	625	626	List Upcharge Full Lockset	Dummy
Oval	•	•	•				20.80	10.40
Traditional	•	•	•				20.80	10.40
Modern		•	•	•			16.60	8.30
Flat Round		•	•		•	•	10.40	5.20
Flat Square		•	•	•	•	•	16.60	8.30

Note: Decorative rosettes ship separate as kit.

LIST PRICE

Featuring Push Button Locking with Free Interiors

DESIGN	FUNCTION	NO	605	625	626	609	619	620	GM Gun Metal	BSP Black Suede	613E	US10BP
Academy (AC)	Dummy	81	N/A	N/A	28.10	28.10	28.10	N/A	N/A	N/A	N/A	N/A
	Passage	11	N/A	N/A	66.00	66.00	66.00	N/A	N/A	N/A	N/A	N/A
	One Sided w/plate	61	N/A	N/A	66.00	66.00	66.00	N/A	N/A	N/A	N/A	N/A
	Privacy**	21	N/A	N/A	70.40	70.40	70.40	N/A	N/A	N/A	N/A	N/A
	Entry (Lever/Lever)**	71	N/A	N/A	109.20	109.20	109.20	N/A	N/A	N/A	N/A	N/A
	Entry (T - Turn)	73	N/A	N/A	109.20	109.20	109.20	N/A	N/A	N/A	N/A	N/A
	Classroom	76	N/A	N/A	109.20	109.20	109.20	N/A	N/A	N/A	N/A	N/A
	Storeroom	79	N/A	N/A	109.20	109.20	109.20	N/A	N/A	N/A	N/A	N/A
Augusta (AU)	Dummy	81	29.10	N/A	29.10	29.10	29.10	N/A	N/A	N/A	30.20	30.20
	Passage	11	69.70	N/A	69.70	69.70	69.70	N/A	N/A	N/A	71.80	71.80
	One Sided w/plate	61	69.70	N/A	69.70	69.70	69.70	N/A	N/A	N/A	71.80	71.80
	Privacy**	21	78.00	N/A	78.00	78.00	78.00	N/A	N/A	N/A	80.10	80.10
	Entry (Lever/Lever)**	71	117.50	N/A	117.50	117.50	117.50	N/A	N/A	N/A	119.60	119.60
	Entry (T - Turn)	73	117.50	N/A	117.50	117.50	117.50	N/A	N/A	N/A	119.60	119.60
	Entry SFIC	74LC	117.50	N/A	117.50	117.50	117.50	N/A	N/A	N/A	119.60	119.60
	Classroom	76	117.50	N/A	117.50	117.50	117.50	N/A	N/A	N/A	119.60	119.60
Storeroom	79	117.50	N/A	117.50	117.50	117.50	N/A	N/A	N/A	119.60	119.60	
Charleston (CH)	Dummy	81	N/A	N/A	29.10	N/A	29.10	N/A	N/A	29.10	30.20	N/A
	Passage	11	N/A	N/A	69.70	N/A	69.70	N/A	N/A	69.70	71.80	N/A
	One Sided w/plate	61	N/A	N/A	69.70	N/A	69.70	N/A	N/A	69.70	71.80	N/A
	Privacy**	21	N/A	N/A	78.00	N/A	78.00	N/A	N/A	78.00	80.10	N/A
	Entry (Lever/Lever)**	71	N/A	N/A	117.50	N/A	117.50	N/A	N/A	117.50	119.60	N/A
	Entry (T - Turn)	73	N/A	N/A	117.50	N/A	117.50	N/A	N/A	117.50	119.60	N/A
	Classroom	76	N/A	N/A	117.50	N/A	117.50	N/A	N/A	117.50	119.60	N/A
	Storeroom	79	N/A	N/A	117.50	N/A	117.50	N/A	N/A	117.50	119.60	N/A
Delaware (DW)	Dummy	81	N/A	29.10	29.10	N/A	29.10	N/A	N/A	29.10	30.20	31.20
	Passage	11	N/A	69.70	69.70	N/A	69.70	N/A	N/A	69.70	71.80	71.80
	One Sided w/plate	61	N/A	69.70	69.70	N/A	69.70	N/A	N/A	69.70	71.80	71.80
	Privacy**	21	N/A	78.00	78.00	N/A	78.00	N/A	N/A	78.00	80.10	80.10
	Bath*	22	N/A	81.10	81.10	N/A	81.10	N/A	N/A	81.10	83.20	83.20
	Entry (Lever/Lever)**	71	N/A	117.50	117.50	N/A	117.50	N/A	N/A	117.50	119.60	119.60
	Entry (T - Turn)	73	N/A	117.50	117.50	N/A	117.50	N/A	N/A	117.50	119.60	119.60
	Classroom	76	N/A	117.50	117.50	N/A	117.50	N/A	N/A	117.50	119.60	119.60
Storeroom	79	N/A	117.50	117.50	N/A	117.50	N/A	N/A	117.50	119.60	119.60	
Kincaid (KC)	Dummy	81	34.00	N/A	34.00	N/A	34.00	N/A	N/A	34.00	N/A	N/A
	Passage	11	78.00	N/A	78.00	N/A	78.00	N/A	N/A	78.00	N/A	N/A
	One Sided w/plate	61	78.00	N/A	78.00	N/A	78.00	N/A	N/A	78.00	N/A	N/A
	Privacy**	21	82.20	N/A	82.20	N/A	82.20	N/A	N/A	82.20	N/A	N/A
	Entry (Lever/Lever)**	71	122.70	N/A	122.70	N/A	122.70	N/A	N/A	122.70	N/A	N/A
	Entry (T - Turn)	73	122.70	N/A	122.70	N/A	122.70	N/A	N/A	122.70	N/A	N/A
	Classroom	76	122.70	N/A	122.70	N/A	122.70	N/A	N/A	122.70	N/A	N/A
	Storeroom	79	122.70	N/A	122.70	N/A	122.70	N/A	N/A	122.70	N/A	N/A

* Bath Function has 625 Polished Chrome Interior
 ** ADA Push Button Locking

Heritage Collection Grade 2 Levers

LIST PRICE Featuring Push Button Locking with Free Interiors

DESIGN	FUNCTION BHMA	NO	US3 605	US26 625	US26D 626	US5 609	US15 619	US15A 620	GM Gun Metal	BSP Black Suede	10BE 613E	US10BP
Kincaid Black Insert (KCB)	Dummy	81	38.50	N/A	N/A	N/A	38.50	N/A	N/A	N/A	N/A	39.50
	Passage	11	99.40	N/A	N/A	N/A	99.40	N/A	N/A	N/A	N/A	101.50
	Privacy**	21	106.10	N/A	N/A	N/A	106.10	N/A	N/A	N/A	N/A	108.20
	Entry (Lever/Lever)**	71	133.10	N/A	N/A	N/A	133.10	N/A	N/A	N/A	N/A	135.20
	Classroom	76	133.10	N/A	N/A	N/A	133.10	N/A	N/A	N/A	N/A	135.20
	Storeroom	79	133.10	N/A	N/A	N/A	133.10	N/A	N/A	N/A	N/A	135.20
Marina (MA)	Dummy	81	N/A	29.10	29.10	N/A	29.10	N/A	29.10	N/A	30.20	30.20
	Passage	11	N/A	69.70	69.70	N/A	69.70	N/A	69.70	N/A	71.80	71.80
	One Sided w/plate	61	N/A	69.70	69.70	N/A	69.70	N/A	69.70	N/A	71.80	71.80
	Privacy*	21	N/A	78.00	78.00	N/A	78.00	N/A	78.00	N/A	80.10	80.10
	Bath*	22	N/A	81.10	81.10	N/A	81.10	N/A	81.10	N/A	83.20	83.20
	Entry (Lever/Lever)**	71	N/A	117.50	117.50	N/A	117.50	N/A	117.50	N/A	119.60	119.60
	Entry (T - Turn)	73	N/A	117.50	117.50	N/A	117.50	N/A	117.50	N/A	119.60	119.60
	Classroom	76	N/A	117.50	117.50	N/A	117.50	N/A	117.50	N/A	119.60	119.60
	Storeroom	79	N/A	117.50	117.50	N/A	117.50	N/A	113.00	N/A	115.00	115.00
McClure (MC)	Dummy	81	28.10	N/A	28.10	N/A	28.10	28.10	N/A	N/A	29.10	29.10
	Passage	11	66.00	N/A	66.00	N/A	66.00	66.00	N/A	N/A	68.10	68.10
	One Sided w/plate	61	66.00	N/A	66.00	N/A	66.00	66.00	N/A	N/A	68.10	68.10
	Privacy**	21	70.40	N/A	70.40	N/A	70.40	70.40	N/A	N/A	72.50	72.50
	Entry (Lever/Lever)**	71	109.20	N/A	109.20	N/A	109.20	109.20	N/A	N/A	111.30	111.30
	Entry (T - Turn)	73	109.20	N/A	109.20	N/A	109.20	109.20	N/A	N/A	111.30	111.30
	Classroom	76	109.20	N/A	109.20	N/A	109.20	109.20	N/A	N/A	111.30	111.30
	Storeroom	79	109.20	N/A	109.20	N/A	109.20	109.20	N/A	N/A	111.30	111.30
Milan (MN)	Dummy	81	28.10	28.10	28.10	N/A	28.10	N/A	N/A	N/A	N/A	N/A
	Passage	11	66.00	66.00	66.00	N/A	66.00	N/A	N/A	N/A	N/A	N/A
	One Sided w/plate	61	66.00	66.00	66.00	N/A	66.00	N/A	N/A	N/A	N/A	N/A
	Privacy**	21	70.40	70.40	70.40	N/A	70.40	N/A	N/A	N/A	N/A	N/A
	Bath*	22	73.50	73.50	73.50	N/A	73.50	N/A	N/A	N/A	N/A	N/A
	Entry (Lever/Lever)**	71	109.20	109.20	109.20	N/A	109.20	N/A	N/A	N/A	N/A	N/A
	Entry (T - Turn)	73	109.20	109.20	109.20	N/A	109.20	N/A	N/A	N/A	N/A	N/A
	Classroom	76	109.20	109.20	109.20	N/A	109.20	N/A	N/A	N/A	N/A	N/A
Storeroom	79	109.20	109.20	109.20	N/A	109.20	N/A	N/A	N/A	N/A	N/A	
Monroe (MO)	Dummy	81	29.10	N/A	29.10	N/A	29.10	N/A	N/A	29.10	30.20	N/A
	Passage	11	69.70	N/A	69.70	N/A	69.70	N/A	N/A	69.70	71.80	N/A
	One Sided w/plate	61	69.70	N/A	69.70	N/A	69.70	N/A	N/A	69.70	71.80	N/A
	Privacy**	21	78.00	N/A	78.00	N/A	78.00	N/A	N/A	78.00	80.10	N/A
	Entry (Lever/Lever)**	71	117.50	N/A	117.50	N/A	117.50	N/A	N/A	117.50	119.60	N/A
	Entry (T - Turn)	73	117.50	N/A	117.50	N/A	117.50	N/A	N/A	117.50	119.60	N/A
	Classroom	76	117.50	N/A	117.50	N/A	117.50	N/A	N/A	117.50	119.60	N/A
	Storeroom	79	117.50	N/A	117.50	N/A	117.50	N/A	N/A	117.50	119.60	N/A
Norwood (NW)	Dummy	81	28.10	28.10	28.10	28.10	28.10	28.10	28.10	28.10	29.10	29.10
	Passage	11	66.00	66.00	66.00	66.00	66.00	66.00	66.00	66.00	68.10	68.10
	One Sided w/plate	61	66.00	66.00	66.00	66.00	66.00	66.00	66.00	66.00	68.10	68.10
	Privacy**	21	70.40	70.40	70.40	70.40	70.40	70.40	70.40	70.40	72.50	72.50
	Bath*	22	73.50	73.50	73.50	73.50	73.50	73.50	73.50	73.50	75.60	75.60
	Entry (Lever/Lever)**	71	109.20	109.20	109.20	109.20	109.20	109.20	109.20	109.20	111.30	111.30
	Entry (T - Turn)	73	109.20	109.20	109.20	109.20	109.20	109.20	109.20	109.20	111.30	111.30
	Classroom	76	109.20	109.20	109.20	109.20	109.20	109.20	109.20	109.20	111.30	111.30
	Storeroom	79	109.20	109.20	109.20	109.20	109.20	109.20	109.20	109.20	111.30	111.30
Pacific Beach (PB)	Dummy	81	29.10	29.10	29.10	29.10	29.10	N/A	N/A	N/A	30.20	N/A
	Passage	11	69.70	69.70	69.70	69.70	69.70	N/A	N/A	N/A	71.80	N/A
	One Sided w/plate	61	69.70	69.70	69.70	69.70	69.70	N/A	N/A	N/A	71.80	N/A
	Privacy**	21	78.00	78.00	78.00	78.00	78.00	N/A	N/A	N/A	80.10	N/A
	Bath*	22	81.10	81.10	81.10	81.10	81.10	N/A	N/A	N/A	83.20	N/A
	Entry (Lever/Lever)**	71	117.50	117.50	117.50	117.50	117.50	N/A	N/A	N/A	119.60	N/A
	Entry (T - Turn)	73	117.50	117.50	117.50	117.50	117.50	N/A	N/A	N/A	119.60	N/A
	Classroom	76	117.50	117.50	117.50	117.50	117.50	N/A	N/A	N/A	119.60	N/A
	Storeroom	79	117.50	117.50	117.50	117.50	117.50	N/A	N/A	N/A	119.60	N/A

* Bath Function has 625 Polished Chrome Interior
** ADA Push Button Locking

Heritage Collection Grade 2 Levers

LIST PRICE Featuring Push Button Locking with Free Interiors

DESIGN	FUNCTION BHMA	NO	605	625	626	609	619	620	GM Gun Metal	BSP Black Suede	613E	US10BP
Valdosta (VL)	Dummy	81	N/A	29.10	29.10	N/A	29.10	N/A	N/A	29.10	30.20	30.20
	Passage	11	N/A	69.70	69.70	N/A	69.70	N/A	N/A	69.70	71.80	71.80
	One Sided w/plate	61	N/A	69.70	69.70	N/A	69.70	N/A	N/A	69.70	71.80	71.80
	Privacy**	21	N/A	78.00	78.00	N/A	78.00	N/A	N/A	78.00	80.10	80.10
	Bath*	22	N/A	81.10	81.10	N/A	81.10	N/A	N/A	81.10	83.20	83.20
	Entry (Lever/Lever)**	71	N/A	117.50	117.50	N/A	117.50	N/A	N/A	117.50	119.60	119.60
	Entry (T - Turn)	73	N/A	117.50	117.50	N/A	117.50	N/A	N/A	117.50	119.60	119.60
	Classroom	76	N/A	117.50	117.50	N/A	117.50	N/A	N/A	117.50	119.60	119.60
Valdosta SQR Rose (VLSQ)	Dummy	81	N/A	37.40	37.40	N/A	37.40	N/A	N/A	37.40	N/A	N/A
	Passage	11	N/A	86.30	86.30	N/A	86.30	N/A	N/A	86.30	N/A	N/A
	One Sided w/plate	61	N/A	86.30	86.30	N/A	86.30	N/A	N/A	86.30	N/A	N/A
	Privacy**	21	N/A	94.60	94.60	N/A	94.60	N/A	N/A	94.60	N/A	N/A
	Bath*	22	N/A	97.80	97.80	N/A	97.80	N/A	N/A	97.80	N/A	N/A
	Entry (Lever/Lever)**	71	N/A	134.20	134.20	N/A	134.20	N/A	N/A	134.20	N/A	N/A
	Entry (T - Turn)	73	N/A	134.20	134.20	N/A	134.20	N/A	N/A	134.20	N/A	N/A
	Classroom	76	N/A	134.20	134.20	N/A	134.20	N/A	N/A	134.20	N/A	N/A
Virgo (VG)	Dummy	81	28.10	28.10	28.10	N/A	28.10	28.10	N/A	28.10	29.10	29.10
	Passage	11	66.00	66.00	66.00	N/A	66.00	66.00	N/A	66.00	68.10	68.10
	One Sided w/plate	61	66.00	66.00	66.00	N/A	66.00	66.00	N/A	66.00	68.10	68.10
	Privacy**	21	70.40	70.40	70.40	N/A	70.40	70.40	N/A	70.40	72.50	72.50
	Bath*	22	N/A	N/A	N/A	N/A	N/A	73.50	N/A	N/A	75.60	75.60
	Entry (Lever/Lever)**	71	109.20	109.20	109.20	N/A	109.20	109.20	N/A	109.20	111.30	111.30
	Entry (T - Turn)	73	109.20	109.20	109.20	N/A	109.20	109.20	N/A	109.20	111.30	111.30
	Classroom	76	109.20	109.20	109.20	N/A	109.20	109.20	N/A	109.20	111.30	111.30
Storeroom	79	109.20	109.20	109.20	N/A	109.20	109.20	N/A	109.20	111.30	111.30	

* Bath Function has 625 Polished Chrome Interior
** ADA Push button locking

AVAILABLE OPTIONS		LIST PRICE UPCHARGE
Rosettes - Traditional, Oval	Full Lockset	20.80
Rosettes - Traditional, Oval	Dummy	10.40
Rosettes - Flat Round	Full Lockset	10.40
Rosettes - Flat Round	Dummy	5.20
Rosettes - Flat Square & Modern	Full Lockset	16.60
Rosettes - Flat Square & Modern	Dummy	8.30
Accessory Stemmed Dummy Plate	YR073003	6.20
(allows a Dummy with Stems to be created from 2 Standard Dummy Trims)		
	UL 90 Minute listing	6.20
	UL 90 Minute listing	Combo Sets

HOW TO DETERMINE HANDING OF DOORS

- The handing of a door is always determined by facing the exterior of a door.
- If the hinge is on the left side of the door, the door is left handed (LH).
- If the hinge is on the right side of the door, the door is right handed (RH).
- To order a handed product, specify LH or RH. Not all products are handed; only specify handing when required.



Storeroom, Classroom, Dummies, and Interior Packs require handing

AVAILABLE OPTIONS	LIST PRICE UPCHARGE
Page 27 Heritage Collection Grade 2 Series Latches	NC when specified
Page 42 T-Strikes	1.50
Page 42 ANSI 4 7/8" Strike	7.10
Page 42 Other Lockset Strikes	NC when specified
Page 43 Additional keying options	
Page 43 Para cylinder options	3.10
GA Keyway (allow for extended lead time)	Add \$20.00
Extension Kit 2 to 2 1/4" Heritage Collection Grade 2 Knobs/Levers (Passage) # YR076100	5.20 (specify finish)

NOTE: Heritage Collection Grade 2 levers are designed to be reversible to eliminate handing (except for the single dummy, Function #81, and entry functions (Function #72). For the single dummy (Function #81) and entry functions (Function #72), please specify handing either right hand (RH) or left hand (LH) when ordering these functions, or when ordering split finishes.

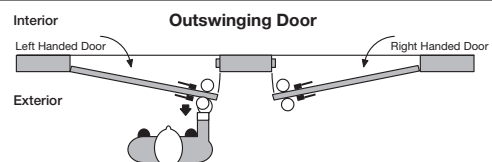
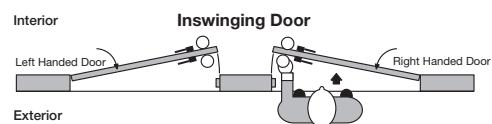

Heritage Collection Grade 2 Deadbolts

82 Premier
Single Cylinder



83 Select
Single Cylinder



85 Select
Double Cylinder





87
One Sided with Plate



Contractors will appreciate our ongoing focus on builder functionality with these finely designed Heritage Collection Grade 2 deadbolts. The Premier Deadbolt “face-removable” design provides easy access to the solid brass cylinder without having to remove the deadbolt from the door. This is a significant benefit to multi-family and multi-unit projects commonly requiring re-keying. The Select Deadbolt offers ANSI Grade 2 strength and security with standard access to the cylinder.

Heritage Collection Grade 2 Deadbolts



FUNCTIONS

FUNCTION	NO.	DESCRIPTION
	82 83	SINGLE CYLINDER: Latch operated from outside by key, inside by T turn.
	85	DOUBLE CYLINDER: Latch operated on either side by key. Concealed screws.

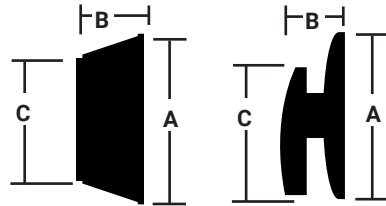
DIMENSIONS	A	B	C
82 Single Exterior	2 ¹⁹ / ₃₂ "	1 ¹ / ₈ "	2"
82 Single Interior	2 ¹ / ₂ "	1 ⁷ / ₈ "	2"
83 Single Exterior	2 ¹ / ₂ "	1"	1 ⁷ / ₈ "
83 Single Interior	2 ¹ / ₂ "	1 ⁷ / ₈ "	2"



PRODUCT SPECIFICATIONS

Door Specs	2 ¹ / ₈ " Face Bore, 1" Edge Bore, 2 ³ / ₈ " or 2 ³ / ₄ " Backset Latch Face 1" x 2 ¹ / ₄ " RC (Round corner; Square corner optional)
Latch	Adjustable 2 ³ / ₈ " or 2 ³ / ₄ " RC (Round Corner)
Door Thickness	1 ³ / ₈ " to 1 ³ / ₄ " 2" to 2 ¹ / ₄ " Requires ext. Kit 07600* 83 Single Cylinder Select Series Only
Cylinder	6 Pin KW-1 Standard (SC-1 Optional)
Keying	KA3 (Keyed Alike)
Faceplate	1" W x 2 ¹ / ₄ " H RC (Round Corner)
Strike	1" x 2 ¹ / ₄ " RC RC (Round Corner)
Certified ANSI/BHMA	A156.36 Grade 2 A156.40 Grade B 
	Meets ADA Guidelines 

Standard Case Quantities - Enter the exact number of individual units required. As an example: If there are 24 units in a case and you require 1 case, enter 24 in the "quantity" space. See below for an example of standard case quantities.

STANDARD CASE QUANTITIES (HERITAGE COLLECTION GRADE 2)

	Box Pack(SP)
Dummy	12
Knobs	24
Levers	12
Deadbolts	12
Combo Sets	12

Available with upcharge.

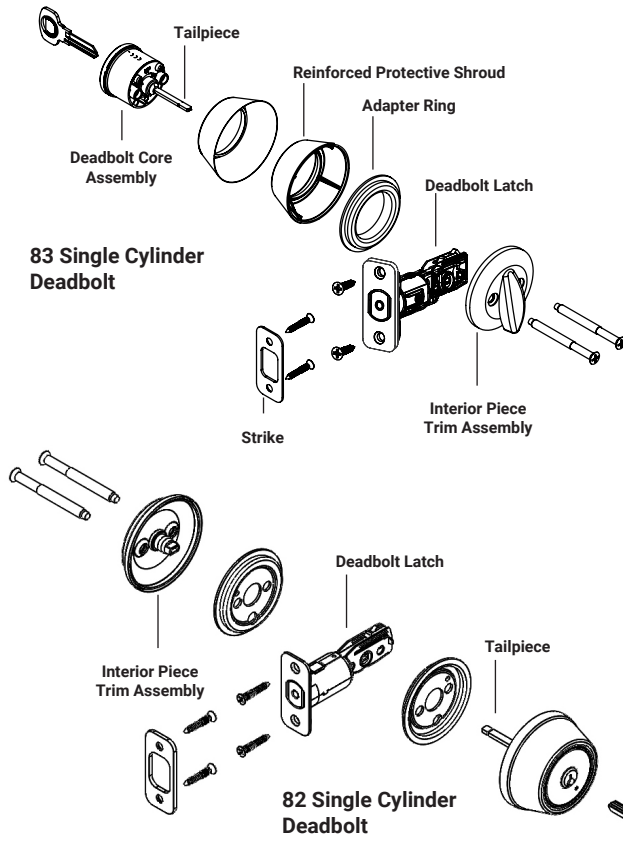

Heritage Collection Grade 2 Deadbolts

		LIST PRICE										
DESIGN	Deadbolts	NO	605	625	626	609	619	620	GM Gun Metal	BSP Black Suede	613E	10BP
Premier	Single Cyl	82	72.60	72.60	72.60	72.60	72.60	72.60	72.60	72.60	78.00	78.00
Premier Series features: Removable Cylinders without removing deadbolt from door, includes high security strike.												
Select	Single Cyl	83	60.10	60.10	60.10	60.10	60.10	60.10	60.10	60.10	65.50	65.50
	Double Cyl	85	69.50	69.50	69.50	69.50	69.50	69.50	69.50	69.50	81.10	81.10
	One Sided w/plate	87	39.50	39.50	39.50	39.50	39.50	39.50	N/A	N/A	N/A	N/A

STRIKES - AVAILABLE OPTIONS















ITEM	CORNER SPECS	MODEL NO	LIST PRICE UPCHARGE
Standard 1" - 2 ¹ / ₄ " SC Strike	Square Corner	YR02082	N/C when specified
Standard 1" - 2 ¹ / ₄ " RC Strike	Round Corner	YR02080	N/C when specified
1 ¹ / ₈ " - 2 ³ / ₄ " SC Universal Deadbolt Strike	Square Corner	YR02086	N/C when specified
1 ¹ / ₈ " - 2 ³ / ₄ " RC Universal Deadbolt Strike	Round Corner	YR02088	N/C when specified
1 ¹ / ₈ " - 2 ³ / ₄ " RC Universal Deadbolt Strike	Round Corner	YR02089	N/C when specified
1 ¹ / ₄ " - 3 ⁵ / ₈ " RC Maximum Security Strike	Round Corner	YR02081	Add \$1.00
1 ¹ / ₄ " - 3 ⁵ / ₈ " SC Maximum Security Strike	Square Corner	YR02083	Add \$1.00
1 ³ / ₄ " - 2 ¹ / ₄ " RC Full Lip Strike^	Round Corner	YR02084	N/C when specified

* Specify finish when ordering

^ Not available for 85 deadbolt

AVAILABLE OPTIONS	LIST PRICE UPCHARGE	AVAILABLE OPTIONS	LIST PRICE UPCHARGE
 UL 90 Minute listing	6.20	Page 27 Heritage Collection Grade 2 Series Latches	NC when specified
UL 90 Minute listing Combo Sets	12.50	Page 43 Additional keying options	
		Page 43 Para cylinder options (Not available for 85 deadbolt)	3.10
		Extension Kit 2 to 2-1/4" Single Deadbolt Only (Thick Door Pack) #YR07600	13.10 (specify finish)

Latch Price List

LIST PRICE					
INTERIOR SPRING LATCHES	DESCRIPTION	DIMENSION	CORNER SPECS	MODEL NO	LIST PRICE
	2 3/8" Spring Latch	1 x 2 1/4"	Square Corner	YR01D05*	11.20
	2 3/8" Spring Latch	1 x 2 1/4"	Round Corner	YR01D02*	11.20
	2 3/4" Spring Latch	1 x 2 1/4"	Square Corner	YR01D06*	11.20
	2 3/4" Spring Latch	1 x 2 1/4"	Round Corner	YR01D08*	11.20
	2 3/8" Spring Drive-In Latch	1" Dia.	N/A	YR01D11*	11.20
	2 3/4" Spring Drive-In Latch	1" Dia.	N/A	YR01D13*	11.20
	2 3/8"-2 3/4" Adj. Spring Latch	1 x 2 1/4"	Square Corner	YR01D17*	11.20
	2 3/8"-2 3/4" Adj. Spring Latch	1 x 2 1/4"	Round Corner	YR01D14*	11.20
	2 3/8"-2 3/4" Adj. Spring Dr. In Latch	1" Dia.	N/A	YR01D71*	11.20
EXTERIOR DEADLOCKING LATCHES	DESCRIPTION	DIMENSION	CORNER SPECS	MODEL NO	LIST PRICE
	2 3/8" Deadlocking Latch	1 x 2 1/4"	Square Corner	YR01D25*	11.20
	2 3/8" Deadlocking Latch	1 x 2 1/4"	Round Corner	YR01D22*	11.20
	2 3/4" Deadlocking Latch	1 x 2 1/4"	Square Corner	YR01D26*	11.20
	2 3/4" Deadlocking Latch	1 x 2 1/4"	Round Corner	YR01D28*	11.20
	2 3/8" Deadlocking Dr. In Latch	1" Dia.	N/A	YR01D32*	11.20
	2 3/4" Deadlocking Dr. In Latch	1" Dia.	N/A	YR01D34*	11.20
	2 3/8"-2 3/4" Adj. Deadlocking Latch	1 x 2 1/4"	Square Corner	YR01D30*	11.20
	2 3/8"-2 3/4" Adj. Deadlocking Latch	1 x 2 1/4"	Round Corner	YR01D31*	11.20
	2 3/8"-2 3/4" Adj. Deadlocking Dr. In Latch	1" Dia.	N/A	YR01D33*	11.20
ADJUSTABLE DEADBOLT LATCHES	DESCRIPTION	DIMENSION	CORNER SPECS	MODEL NO	LIST PRICE
	2 3/8"-2 3/4" Adj. Deadbolt Latch		Square Corner	YR01D44*	11.20
	2 3/8"-2 3/4" Adj. Deadbolt Latch		Round Corner	YR01D41*	11.20
	2 3/8"-2 3/4" Adj. Deadbolt Drive-In Latch	1" Dia.	N/A	YR01D47*	11.20

*Specify finish when ordering

Heritage Collection Grade 3 Knobs

Doors Require Blocking

Cirrus

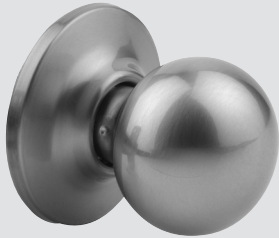

Horizon



Oasis



Terra





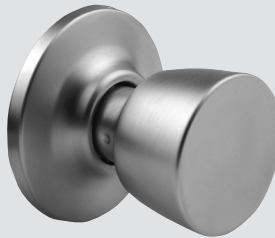



Valley



The ASSA ABLOY ACCENTRA™ standard duty knobs from the Heritage Collection Grade 3 series offer outstanding strength, durability and simple, elegant designs highlighted by natural curves for comfort and ease of turning. The Cirrus, Horizon, Oasis, Terra, and Valley knobs are built to the highest quality standards. These products are built on a steel Grade 3 chassis and feature concealed holding screws. In addition, all Heritage Collection Grade 3 products feature "Quick-Install," a unique chassis design, which drastically reduces installation time. The Heritage Collection Grade 3 series offers all of these superb features at an incredible value.

Heritage Collection Grade 3 Knobs

FUNCTIONS

FUNCTION	NO.	DESCRIPTION
	80	DUMMY: For doors where only pull is required.
	100	PASSAGE: Latchbolt is operated by either knob at all times.
	160	ONE SIDED W/PLATE: Latchbolt is operated by knob on one side only.
	200	PRIVACY: Latchbolt is operated by either knob except when inside knob is locked by turn button. A special emergency key releases turn button and unlocks outside knob.
	226	BATHROOM: Same function as 200 privacy with US26 finish on interior knob.
	700	ENTRY: Guarded Latch bolt operated from outside by key. Inside by knob. Turn button Locks both knobs. Knobs unlock by Key outside or by rotating inside turn button.

DIMENSIONS	A	B	C
Cirrus	2 ⁹ / ₁₆ "	2 ¹ / ₂ "	2"
Horizon	2 ⁹ / ₁₆ "	2 ¹ / ₄ "	2"
Oasis	2 ⁹ / ₁₆ "	2 ¹ / ₄ "	2"
Terra	2 ⁹ / ₁₆ "	2 ³ / ₈ "	2 ¹ / ₂ "
Valley	2 ⁹ / ₁₆ "	2 ⁵ / ₁₆ "	1 ¹⁵ / ₁₆ "

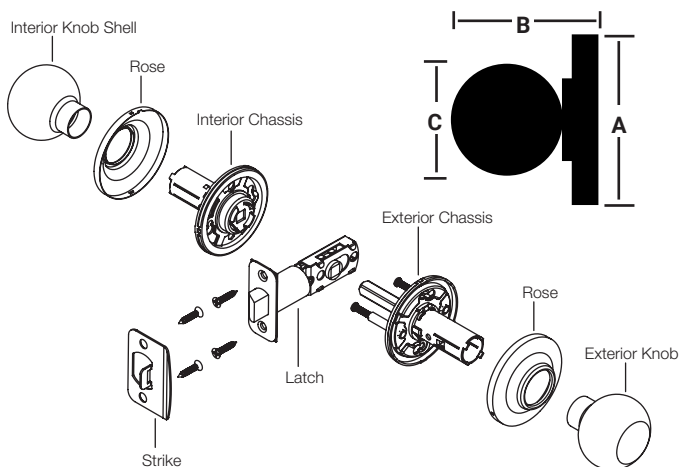

PRODUCT SPECIFICATIONS

Door Specs	2 ¹ / ₈ " Face Bore, 1" Edge Bore, 2 ³ / ₈ " or 2 ³ / ₄ " Backset Latch Face 1" x 2 ¹ / ₄ " Round corner (Square corner optional)
Latch	Adjustable 2 ³ / ₈ " or 2 ³ / ₄ " RC (round corner)
Door Thickness	1 ³ / ₈ " to 1 ³ / ₄ "
Cylinder	5 Pin KW-1 Cylinder Standard (SC-1 Optional)
Keying	KA3 (Keyed Alike)
Faceplate	1" W x 2 ¹ / ₄ " H RC (Round Corner)
Strike	2 ¹ / ₄ " Full Lip RC (Round Corner)
Designed to Meet ANSI/BHMA	A156.2 Series 4000 Grade 3 A156.39 Grade B

Standard Case Quantities - Enter the exact number of individual units required. As an example: If there are 24 units in a case and you require 1 case, enter 24 in the "quantity" space. See below for an example of standard case quantities.

STANDARD CASE QUANTITIES (HERITAGE COLLECTION GRADE 3)

	Box Pack(SP)
Dummy	12
Knobs	24
Levers	12
Deadbolts	12
Combo Sets	12



Available with upcharge.

Heritage Collection Grade 3 Knobs

			LIST PRICE									
DESIGN	FUNCTION BHMA	NO	605	626	609	619	GM Gun Metal	BSP Black Suede	625	620	613E	10BP
Cirrus (C)	Dummy	80	13.00	13.00	N/A	13.00	13.00	N/A	14.00	14.00	14.00	14.00
	Passage	100	28.90	28.90	N/A	28.90	28.90	N/A	31.00	31.00	31.00	31.00
	One Sided w/plate	160	28.90	28.90	N/A	28.90	28.90	N/A	31.00	31.00	31.00	31.00
	Privacy	200	31.20	31.20	N/A	31.20	31.20	N/A	33.30	33.30	33.30	33.30
	Bath*	226	34.30	34.30	N/A	34.30	34.30	N/A	N/A	36.40	36.40	36.40
	Entry	700	39.60	39.60	N/A	39.60	39.60	N/A	41.70	41.70	41.70	41.70
Horizon (H)	Dummy	80	13.00	13.00	13.00	13.00	13.00	13.00	14.00	14.00	14.00	14.00
	Passage	100	28.90	28.90	28.90	28.90	28.90	28.90	31.00	31.00	31.00	31.00
	One Sided w/plate	160	28.90	28.90	28.90	28.90	28.90	28.90	31.00	31.00	31.00	31.00
	Privacy	200	31.20	31.20	31.20	31.20	31.20	31.20	33.30	33.30	33.30	33.30
	Bath*	226	34.30	34.30	34.30	34.30	34.30	34.30	N/A	36.40	36.40	36.40
	Entry	700	39.60	39.60	39.60	39.60	39.60	39.60	41.70	41.70	41.70	41.70
Oasis (O)	Dummy	80	N/A	N/A	N/A	14.00	N/A	N/A	N/A	N/A	N/A	15.10
	Passage	100	N/A	N/A	N/A	30.60	N/A	N/A	N/A	N/A	N/A	32.70
	One Sided w/plate	160	N/A	N/A	N/A	30.60	N/A	N/A	N/A	N/A	N/A	32.70
	Privacy	200	N/A	N/A	N/A	34.00	N/A	N/A	N/A	N/A	N/A	36.10
	Bath*	226	N/A	N/A	N/A	N/A	N/A	N/A	N/A	N/A	N/A	N/A
	Entry	700	N/A	N/A	N/A	43.10	N/A	N/A	N/A	N/A	N/A	45.10
Terra (T)	Dummy	80	N/A	N/A	N/A	17.00	17.00	N/A	N/A	N/A	N/A	18.00
	Passage	100	N/A	N/A	N/A	39.50	39.50	N/A	N/A	N/A	N/A	41.60
	One Sided w/plate	160	N/A	N/A	N/A	39.50	39.50	N/A	N/A	N/A	N/A	41.60
	Privacy	200	N/A	N/A	N/A	41.60	41.60	N/A	N/A	N/A	N/A	43.70
	Bath*	226	N/A	N/A	N/A	N/A	N/A	N/A	N/A	N/A	N/A	N/A
	Entry	700	N/A	N/A	N/A	59.30	59.30	N/A	N/A	N/A	N/A	61.40
Valley (V)	Dummy	80	13.00	13.00	N/A	N/A	N/A	N/A	N/A	N/A	N/A	N/A
	Passage	100	28.90	28.90	N/A	N/A	N/A	N/A	N/A	N/A	N/A	N/A
	One Sided w/plate	160	28.90	28.90	N/A	N/A	N/A	N/A	N/A	N/A	N/A	N/A
	Privacy	200	31.20	31.20	N/A	N/A	N/A	N/A	N/A	N/A	N/A	N/A
	Bath*	226	34.30	34.30	N/A	N/A	N/A	N/A	N/A	N/A	N/A	N/A
	Entry	700	39.60	39.60	N/A	N/A	N/A	N/A	N/A	N/A	N/A	N/A

*Bath Function has 625 Polished Chrome Interior

KNOB COMBO SET – LIST PRICE

Combo Sets Include 1 Entry Knob with 1 Single or 1 Double Deadbolt

DESIGN	FUNCTION BHMA	NO	605	626	609	619	GM Gun Metal	BSP Black Suede	625	620	613E	10BP
Cirrus (C)	Single Cylinder	827	79.20	79.20	N/A	79.20	79.20	N/A	90.00	90.00	90.00	90.00
Horizon (H)	Single Cylinder	827	79.20	79.20	79.20	79.20	79.20	76.20	90.00	90.00	90.00	90.00
Oasis (O)	Single Cylinder	827	N/A	N/A	N/A	82.70	N/A	N/A	N/A	N/A	N/A	98.90
Terra (T)	Single Cylinder	827	N/A	N/A	N/A	98.90	98.90	N/A	N/A	N/A	N/A	106.20
Valley (V)	Single Cylinder	827	79.20	79.20	N/A	N/A	N/A	N/A	N/A	N/A	N/A	N/A

AVAILABLE OPTIONS	LIST PRICE UPCHARGE
 UL 90 Minute listing	6.20
UL 90 Minute listing Combo Sets	12.50

AVAILABLE OPTIONS	LIST PRICE UPCHARGE
Page 37 Heritage Collection Grade 3 Series Latches	NC when specified
Page 42 T-Strikes	1.50
Page 42 ANSI 4 ⁷ / ₈ " Strike	7.10
Page 42 Other Lockset Strikes	NC when specified
Page 43 Additional keying options	

Note: All Heritage Collection Grade 3 entry function leversets will be shipped with the Cirrus knob exterior unless otherwise specified. Heritage Collection Grade 3 levers are designed to be reversible to eliminate handing errors (except for the single dummy, function #81, and entry function #701). For the single dummy (function #81) and entry functions (function #701), please specify handing either right hand (RH) or left hand (LH) when ordering these functions, or when ordering split finishes.

Heritage Collection Grade 3 Levers



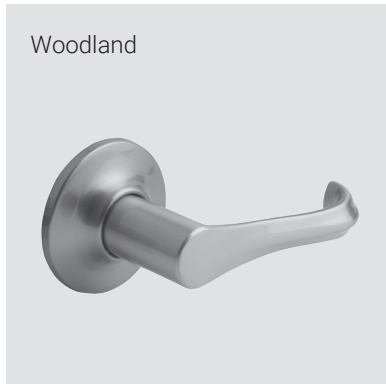



Doors Require Blocking



With concealed holding screws, and a strengthened square spindle, Heritage Collection Grade 3 products reflect an outstanding commitment to quality. Like the Heritage Collection Grade 3 knobs, the levers are exquisitely designed. With free-flowing curves and smooth edges, the Mesa, Niagara, Prairie, Savannah, Vernal, Vidalia, and Woodland levers offer impeccable elegance at an exceptional price.

Heritage Collection Grade 3 Levers

FUNCTIONS

FUNCTION NO.	DESCRIPTION
 81	DUMMY: For doors where only pull is required. (handing required)
 101*	PASSAGE: Latchbolt is operated by either lever at all times. (non-handed)
 161	ONE SIDED W/PLATE: Latchbolt is operated by lever on one side only. (handing required)
 201	PRIVACY: Latchbolt is operated by either lever except when inside lever is locked by turn button. A coin turn releases turn button and unlocks outside lever. (non-handed)
 221	BATHROOM: Same function as 201 privacy with US26 finish on interior lever. (handing required)
 771	ENTRY (LEVER/LEVER): Guarded latch bolt operated from outside lever by key. Inside by lever. Turn button locks both levers. Levers unlock by key or by turning inside turn button.

DIMENSIONS	A	B	C
Mesa	2 ⁹ / ₁₆ "	2 ³ / ₈ "	3 ¹ / ₄ "
Niagara	2 ⁹ / ₁₆ "	2 ¹ / ₂ "	4 ⁷ / ₃₂ "
Savannah	2 ⁹ / ₁₆ "	2 ¹ / ₄ "	3 ⁷ / ₈ "
Prairie	2 ⁹ / ₁₆ "	2 ⁷ / ₁₆ "	4 ¹⁹ / ₆₄ "
Vernal	2 ⁹ / ₁₆ "	2 ⁹ / ₁₆ "	4 ¹ / ₂ "
Vidalia	2 ⁹ / ₁₆ "	2 ¹ / ₂ "	4 ⁵ / ₈ "
Woodland	2 ⁹ / ₁₆ "	2 ⁵ / ₈ "	3 ⁷ / ₈ "

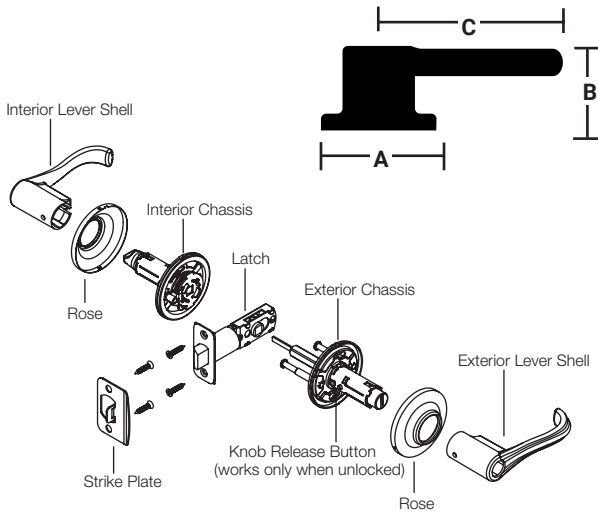

PRODUCT SPECIFICATIONS

Door Specs	2 ¹ / ₈ " Face Bore, 1" Edge Bore, 2 ³ / ₈ " or 2 ³ / ₄ " Backset Latch Face 1" x 2 ¹ / ₄ " Round corner (Square corner optional)
Latch	Adjustable 2 ³ / ₈ " or 2 ³ / ₄ " RC (round corner)
Door Thickness	1 ³ / ₈ " to 1 ³ / ₄ "
Cylinder	5 Pin KW-1 Cylinder Standard (SC-1 Optional)
Keying	KA3 (Keyed Alike)
Faceplate	1" W x 2 ¹ / ₄ " H RC (Round Corner)
Strike	2 ¹ / ₄ " Full Lip RC (Round Corner)
Designed to Meet ANSI/BHMA	A156.2 Series 4000 Grade 3 A156.39 Grade B

Standard Case Quantities - Enter the exact number of individual units required. As an example: If there are 24 units in a case and you require 1 case, enter 24 in the "quantity" space. See below for an example of standard case quantities.

STANDARD CASE QUANTITIES (HERITAGE COLLECTION GRADE 3)

	Box Pack(SP)
Dummy	12
Knobs	24
Levers	12
Deadbolts	12
Combo Sets	12

HOW TO DETERMINE HANDING OF DOORS

- The handing of a door is always determined by facing the exterior of a door.
 - If the hinge is on the left side of the door, the door is left handed (LH).
 - If the hinge is on the right side of the door, the door is right handed (RH).
 - To order a handed product, specify LH or RH.
- Not all products are handed; only specify handing when required.

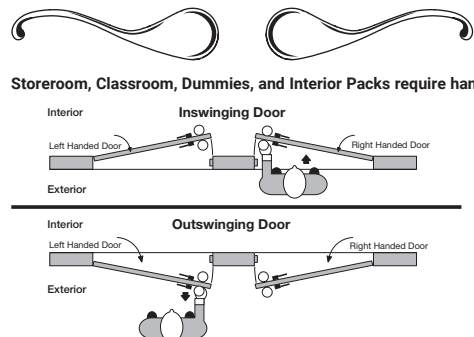

Available with upcharge.

Heritage Collection Grade 3 Levers

Decorative Rosettes

Flat Round 2-9/16" Dia
Center Hole: 1-1/32"

Flat Square 2-9/16" W x 2-9/16" H
Center Hole: 1-1/32"

Modern 2-9/16" W x 3" H
Center Hole: 1-1/32"

Flat Round Flat Square Modern

Pair with all Heritage Grade 3 lever styles.

Rosette Availability	605	10BP	619	BSP	625	626	List Upcharge Full Lockset	Dummy
Flat Round		•	•			•	10.00	5.00
Flat Square		•	•	•	•		16.00	8.00
Modern		•	•	•			16.00	8.00

Note: Decorative rosettes ship separate as kit.

LIST PRICE

Levers	DESIGN	FUNCTION	NO	605	626	609	619	GM Gun Metal	BSP Black Suede	625	620	613E	10BP
Featuring Quick Install Design													
Mesa (ML)		Dummy	81	N/A	20.40	20.40	20.40	N/A	N/A	N/A	N/A	21.90	N/A
		Passage	101	N/A	48.30	48.30	48.30	N/A	N/A	N/A	N/A	51.40	N/A
		One Sided w/plate	161	N/A	48.30	48.30	48.30	N/A	N/A	N/A	N/A	51.40	N/A
	Not available	Privacy	201	N/A	50.30	50.30	50.30	N/A	N/A	N/A	N/A	53.50	N/A
	771 lever x lever entry	Entry (Knob/Lever)	701	N/A	64.40	64.40	64.40	N/A	N/A	N/A	N/A	67.50	N/A
Niagara (NL)		Dummy	81	20.40	20.40	20.40	20.40	20.40	20.40	21.90	21.90	21.90	21.90
		Passage	101	48.30	48.30	48.30	48.30	48.30	48.30	51.40	51.40	51.40	51.40
		One Sided w/plate	161	48.30	48.30	48.30	48.30	48.30	48.30	51.40	51.40	51.40	51.40
		Privacy	201	50.30	50.30	50.30	50.30	50.30	50.30	53.50	53.50	53.50	53.50
		Bath*	221	53.50	53.50	53.50	53.50	53.50	53.50	N/A	56.60	56.60	56.60
	Entry (Lever/Lever)	771	70.30	70.30	70.30	70.30	70.30	70.30	73.40	73.40	73.40	73.40	
Prairie (PL)		Dummy	81	N/A	20.40	20.40	20.40	N/A	N/A	21.90	N/A	N/A	N/A
		Passage	101	N/A	48.30	48.30	48.30	N/A	N/A	51.40	N/A	N/A	N/A
		One Sided w/plate	161	N/A	48.30	48.30	48.30	N/A	N/A	51.40	N/A	N/A	N/A
		Privacy	201	N/A	50.30	50.30	50.30	N/A	N/A	53.50	N/A	N/A	N/A
		Bath*	221	N/A	53.50	53.50	53.50	N/A	N/A	N/A	N/A	N/A	N/A
	Entry (Lever/Lever)	771	N/A	70.30	70.30	70.30	N/A	N/A	73.40	N/A	N/A	N/A	
Savannah (SL)		Dummy	81	20.40	20.40	20.40	20.40	20.40	20.40	21.90	21.90	21.90	21.90
		Passage	101	48.30	48.30	48.30	48.30	48.30	48.30	51.40	51.40	51.40	51.40
		One Sided w/plate	161	48.30	48.30	48.30	48.30	48.30	48.30	51.40	51.40	51.40	51.40
		Privacy	201	50.30	50.30	50.30	50.30	50.30	50.30	53.50	53.50	53.50	53.50
		Bath*	221	53.50	53.50	53.50	53.50	53.50	53.50	N/A	56.60	56.60	56.60
	Entry (Lever/Lever)	771	70.30	70.30	70.30	70.30	70.30	70.30	73.40	73.40	73.40	73.40	
Vernal (VE)		Dummy	81	N/A	20.40	N/A	20.40	N/A	20.40	N/A	N/A	21.90	21.90
		Passage	101	N/A	48.30	N/A	48.30	N/A	48.30	N/A	N/A	51.40	51.40
		One Sided w/plate	161	N/A	48.30	N/A	48.30	N/A	48.30	N/A	N/A	51.40	51.40
		Privacy	201	N/A	50.30	N/A	50.30	N/A	50.30	N/A	N/A	53.50	53.50
		Entry (Lever/Lever)	771	N/A	70.30	N/A	70.30	N/A	70.30	N/A	N/A	73.40	73.40
Vidalia (VI)		Dummy	81	N/A	20.40	N/A	20.40	N/A	20.40	21.90	N/A	N/A	21.90
		Passage	101	N/A	48.30	N/A	48.30	N/A	48.30	51.40	N/A	N/A	51.40
		One Sided w/plate	161	N/A	48.30	N/A	48.30	N/A	48.30	51.40	N/A	N/A	51.40
		Privacy	201	N/A	50.30	N/A	50.30	N/A	50.30	53.50	N/A	N/A	53.50
		Bath*	221	N/A	53.50	N/A	53.50	N/A	53.50	56.60	N/A	N/A	56.60
	Entry (Lever/Lever)	771	N/A	70.30	N/A	70.30	N/A	70.30	73.40	N/A	N/A	73.40	
Vidalia SQR Rose (VISQ)		Dummy	81	N/A	N/A	N/A	28.70	N/A	28.70	N/A	N/A	N/A	30.30
		Passage	101	N/A	N/A	N/A	64.90	N/A	64.90	N/A	N/A	N/A	68.00
		One Sided w/plate	161	N/A	N/A	N/A	64.90	N/A	64.90	N/A	N/A	N/A	68.00
		Privacy	201	N/A	N/A	N/A	67.00	N/A	67.00	N/A	N/A	N/A	70.10
		Bath*	221	N/A	N/A	N/A	70.10	N/A	70.10	N/A	N/A	N/A	73.20
	Entry (Lever/Lever)	771	N/A	N/A	N/A	95.70	N/A	95.70	N/A	N/A	N/A	98.80	
Woodland (WL)		Dummy	81	20.40	20.40	20.40	20.40	20.40	20.40	21.90	21.90	21.90	21.90
		Passage	101	48.30	48.30	48.30	48.30	48.30	48.30	51.40	51.40	51.40	51.40
		One Sided w/plate	161	48.30	48.30	48.30	48.30	48.30	48.30	51.40	51.40	51.40	51.40
		Privacy	201	50.30	50.30	50.30	50.30	50.30	50.30	53.50	53.50	53.50	53.50
		Bath*	221	53.50	53.50	53.50	53.50	53.50	53.50	56.60	56.60	56.60	56.60
	Entry (Lever/Lever)	771	70.30	70.30	70.30	70.30	70.30	70.30	73.40	73.40	73.40	73.40	

*Bath Function has 625 Polished Chrome Interior

AVAILABLE OPTIONS	LIST PRICE UPCHARGE	AVAILABLE OPTIONS	LIST PRICE UPCHARGE
<ul style="list-style-type: none"> UL 90 Minute listing UL 90 Minute listing Combo Sets 	6.20	Page 37 Heritage Collection Grade 3 Series Latches	NC when specified
	12.50	Page 42 T-Strikes	1.50
		Page 42 ANSI 4 ⁷ / ₈ " Strike	7.10
		Page 42 Other Lockset Strikes	NC when specified
		Page 43 Additional keying options	

Note: All Heritage Collection Grade 3 entry function leversets will be shipped with the Cirrus knob exterior unless otherwise specified. Heritage Collection Grade 3 levers are designed to be reversible to eliminate handing errors (except for the single dummy function #81, and entry function #701). For the single dummy (function #81) and entry functions (function #701), please specify handing either right hand (RH) or left hand (LH) when ordering these functions, or when ordering split finishes.

Heritage Collection Grade 3 Deadbolts

810
Dummy



820
Single Cylinder



840
Double Cylinder



860
One Sided
with plate

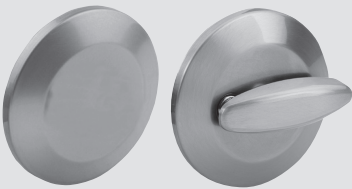

880
One Way

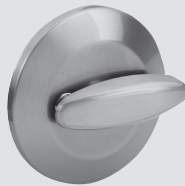

820R
Single Cylinder



820S
Single Cylinder







820M
Single Cylinder



The ASSA ABLOY ACCENTRA™ 800 series deadbolts offer a variety of functions and finishes, and are compatible with all Heritage Collection Grade 3 leversets and knobsets. The 800 series deadbolts offer excellent strength and reliability, certified to an ANSI Grade 3.

Heritage Collection Grade 3 Deadbolts

FUNCTIONS

FUNCTION	NO.	DESCRIPTION
	810	DUMMY: No cylinder, no latch
	820	SINGLE CYLINDER: Latch operated from the outside by key, inside by T-turn.
	840	DOUBLE CYLINDER: Latch operated from either side by the key.
	860	ONE SIDED DEADBOLT WITH PLATE: No cylinder. Latch operated by the T-turn on the inside. For doors bored completely through.
	880	ONE WAY: No cylinder. Latch operated by the T-turn on the inside. For doors not bored completely through.

PRODUCT SPECIFICATIONS

Door Specs	2 ¹ / ₈ " Face Bore, 1" Edge Bore, Latch Face 1" x 2 ¹ / ₄ " Round corner (Square corner optional)
Latch	Adjustable 2 ³ / ₈ " or 2 ³ / ₄ " RC (round corner)
Door Thickness	1 ³ / ₈ " to 1 ³ / ₄ "
Cylinder	5 Pin KW-1 Cylinder Standard (SC-1 Optional)
Keying	KA3 (Keyed Alike)
Faceplate	1" W x 2 ¹ / ₄ " H RC (Round Corner)
Strike	1"x2 ¹ / ₄ " RC RC (Round Corner)
Certified ANSI/BHMA	A156.36 Grade 3 A156.40 Grade C 

Meets ADA Guidelines 

DIMENSIONS	A	B	C
800 Interior	2 ¹ / ₂ "	1 ⁵ / ₁₆ "	2"
800 Exterior	2 ¹ / ₂ "	1"	1 ⁷ / ₈ "
820R/820S Interior	2 ¹ / ₂ "	7/ ₈ "	1 ⁵ / ₁₆ "
820R/820S Exterior	2 ¹ / ₂ "	7/ ₈ "	2 ¹ / ₂ "
820M Interior	3"	1"	2"
820M Exterior	3"	7/ ₈ "	2 ³ / ₈ "

Standard Case Quantities - Enter the exact number of individual units required. As an example: If there are 24 units in a case and you require 1 case, enter 24 in the "quantity" space. See below for an example of standard case quantities.

STANDARD CASE QUANTITIES (Heritage Collection Grade 3)	BOX PACK(SP)
Dummy	12
Knobs	24
Levers	12
Deadbolts	12
Combo Sets	12

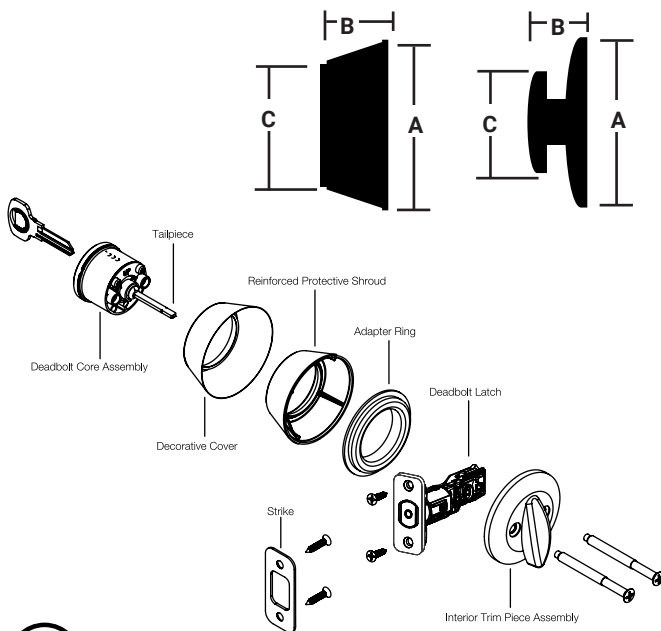

 Available with upcharge.

Heritage Collection Grade 3 Deadbolts

		LIST PRICE										
800 SERIES DEADBOLTS	FUNCTION	NO BHMA	605	626	609	619	GM Gun Metal	BSP Black Suede	625	620	613E	US10BP
	Dummy	810	29.10	29.10	29.10	29.10	N/A	N/A	34.30	34.30	N/A	34.30
	Single Cylinder	820	39.60	39.60	39.60	39.60	39.60	39.60	44.80	44.80	44.80	44.80
	Double Cylinder	840	49.90	49.90	49.90	49.90	49.90	49.90	55.10	55.10	55.10	55.10
	One Sided W/Plate	860	32.90	32.90	32.90	32.90	32.90	32.90	38.10	38.10	38.10	38.10
	Oneway*	880	23.90	23.90	23.90	23.90	23.90	23.90	30.20	30.20	30.20	30.20
Only available 20 minute UL	Flat Round Single Cyl**	820R	57.80	57.80	57.80	57.80	57.80	57.80	62.00	62.00	62.00	62.00
	Flat Square Single Cyl**	820S	57.80	57.80	57.80	57.80	57.80	57.80	62.00	62.00	62.00	62.00
	Modern Single Cyl **	820M	N/A	N/A	N/A	57.80	N/A	57.80	N/A	N/A	N/A	62.00

*880 deadbolt available fixed latch only. 2-3/8 RC is Std.

**Only available 20 minute UL

STRIKES - AVAILABLE OPTIONS

ITEM	CORNER SPECS	MODEL NO	LIST PRICE UPCHARGE
Standard 1" - 2 1/4" /SC Strike	Square Corner	YR02082	N/C when specified
Standard 1" - 2 1/4" /RC Strike	Round Corner	YR02080	N/C when specified
1 1/8" - 2 3/4" /SC Strike	Square Corner	YR02086	N/C when specified
1 1/8" - 2 3/4" /RC Strike	Round Corner	YR02088	N/C when specified
1 1/4" - 3 5/8" /RC Maximum Security Strike	Square Corner	YR02081	Add \$1.00
1 1/4" - 3 5/8" /SC Maximum Security Strike	Round Corner	YR02083	Add \$1.00
1 3/4" - 2 1/4" /RC Full Lip Strike	Round Corner	YR02084	N/C when specified
Screw Pack (4 each 3" Screws)		08818*	1.60









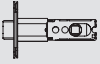

* Specify finish when ordering

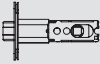
AVAILABLE OPTIONS

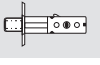
	LIST PRICE UPCHARGE
 UL 90 Minute listing	6.20
UL 90 Minute listing Combo Sets	12.50

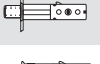
Heritage Collection Grade 3

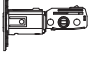
Latch Price List

LIST PRICE					
INTERIOR SPRING LATCHES	DESCRIPTION	DIMENSION	CORNER SPECS	MODEL NO	LIST PRICE
	2 3/8"-2 3/4" Adj. Spring Latch	1 x 2 1/4"	Square Corner	YR01464*	6.20
	2 3/8"-2 3/4" Adj. Spring Latch	1 x 2 1/4"	Round Corner	YR01461*	6.20
	2 3/8"-2 3/4" Drive-In Spring Latch	1" Dia.	N/A	YR01D71*	10.60
EXTERIOR DEADLOCKING LATCHES	DESCRIPTION	DIMENSION	CORNER SPECS	MODEL NO	LIST PRICE
	2 3/8"-2 3/4" Adj. Deadlocking Latch	1 x 2 1/4"	Square Corner	YR01474*	7.30
	2 3/8"-2 3/4" Adj. Deadlocking Latch	1 x 2 1/4"	Round Corner	YR01471*	7.30
	2 3/8"-2 3/4" Adj. Deadlocking Drive.-In Latch	1" Dia.	N/A	YR01D33*	10.60
DEADBOLT LATCHES 880 Deadbolt Only	DESCRIPTION	DIMENSION	CORNER SPECS	MODEL NO	LIST PRICE
	2 3/8" Deadbolt Latch	1 x 2 1/4"	Square Corner	YR01445*	10.60
	2 3/8" Deadbolt Latch	1 x 2 1/4"	Round Corner	YR01442*	10.60
	2 3/8" Deadbolt Drive-In Latch	1" Dia.	N/A	YR01448*	10.60
	2 3/4" Deadbolt Latch	1 x 2 1/4"	Square Corner	YR01446*	10.60
	2 3/4" Deadbolt Latch	1 x 2 1/4"	Round Corner	YR01443*	10.60
	2 3/4" Deadbolt Drive-In Latch	1" Dia.	N/A	YR01449*	10.60
ADJUSTABLE DEADBOLT LATCHES 820, 840, 860 Deadbolts & Handlesets	DESCRIPTION	DIMENSION	CORNER SPECS	MODEL NO	LIST PRICE
	2 3/8"-2 3/4" Adj. Deadbolt Latch		Square Corner	YR01D44*	10.60
	2 3/8"-2 3/4" Adj. Deadbolt Latch		Round Corner	YR01D41*	10.60
	2 3/8"-2 3/4" Adj. Deadbolt Drive-In Latch	1" Dia.	N/A	YR01D47*	10.60

*Specify finish when ordering

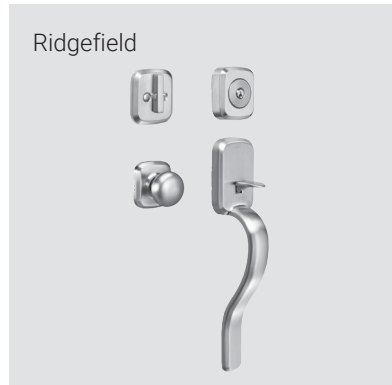
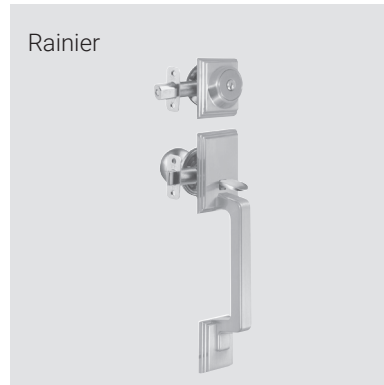
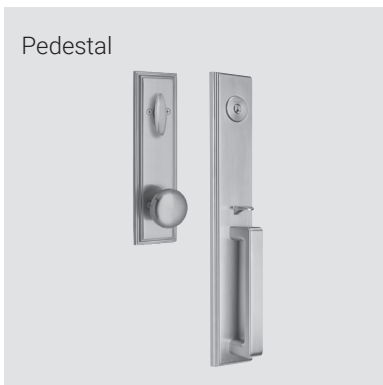

Decorative Handlesets



Our decorative handlesets combine elegance with ease of installation. These designs offer balanced torque springs on a split-hub for ease of opening, solid thumb pieces, and finishes utilizing the world's most advanced clear coat technology. Designed to fit most American-made doors, each handleset comes with easy-to-read installation instructions.

Decorative Handlesets

FUNCTIONS

FUNCTION	NO.	DESCRIPTION
	681 682 986 987 988 989	DUMMY: For on-working side of double doors. Non-functioning deadbolt, knob or lever.
	621 622 926 927 928 929	SINGLE CYLINDER: Thumbpiece retracts latch from exterior side. Knob or lever retracts latch from interior side. Deadbolt latch retracts with key from exterior side, T-turn retracts deadbolt latch from interior side.
	641 642 946 947	DOUBLE CYLINDER: Thumbpiece retracts latch from exterior side. Knob or lever retracts latch from interior side. Deadbolt latch retracts with key from exterior side and interior side.

DIMENSIONS	A	B	C	D
Homestead	2 ³ / ₈ "	5 ¹ / ₂ "	9 ¹¹ / ₁₆ "	18"
Jamestown	2 ³ / ₈ "	5 ¹ / ₂ "	9 ¹¹ / ₁₆ "	18"
McKinley	2 ³ / ₈ "	5 ¹ / ₂ "	9 ¹¹ / ₁₆ "	18"
Pedestal	2 ¹¹ / ₁₆ "	5 ¹ / ₂ "	9 ¹¹ / ₁₆ "	18 ¹ / ₂ "
Rainier	2 ³ / ₈ "	5 ¹ / ₂ "	9 ¹¹ / ₁₆ "	18"
Ridgefield	2 ³ / ₈ "	5 ¹ / ₂ "	9 ¹¹ / ₁₆ "	18"
Teton	2 ³ / ₈ "	5 ¹ / ₂ "	9 ¹¹ / ₁₆ "	18"

PRODUCT SPECIFICATIONS

Door Specs	2 ¹ / ₈ " Face Bore, 1" Edge Bore, 5 ¹ / ₂ " O.C. Latch Face 1" x 2 ¹ / ₄ " RC (Round Corner)
Latch	2 ³ / ₈ " RC (Round Corner) Deadbolt: 2 ³ / ₈ "-2 ³ / ₄ " ADJ. RC (Round Corner) Deadbolt: 2 ³ / ₈ "-2 ³ / ₄ " ADJ. RC (Round Corner)
Door Thickness	1 ³ / ₄ " 2" to 2 ¹ / ₄ " Requires Ext. Kit 07600
Cylinder Keying	KW-1 Compatible KD (Keyed Different)
Faceplate	1" W x 2 ¹ / ₄ " H RC (Round Corner)
Strike	Spring latch 2 ¹ / ₄ " Full Lip RC (Round Corner) Deadbolt: 1" x 2 ¹ / ₄ " RC (Round Corner) Deadbolt: 1" x 2 ¹ / ₄ " RC (Round Corner)
Interior Trim	Specify Interior Trim Style

Standard Case Quantities - Enter the exact number of individual units required. As an example: If there are 24 units in a case and you require 1 case, enter 24 in the "quantity" space. See below for an example of standard case quantities.

STANDARD CASE QUANTITIES	BOX PACK(SP)
Handlesets	6
Handlesets - Interior Pack	6



UL - Not available on ASSA ABLOY ACCENTRA™ Handlesets

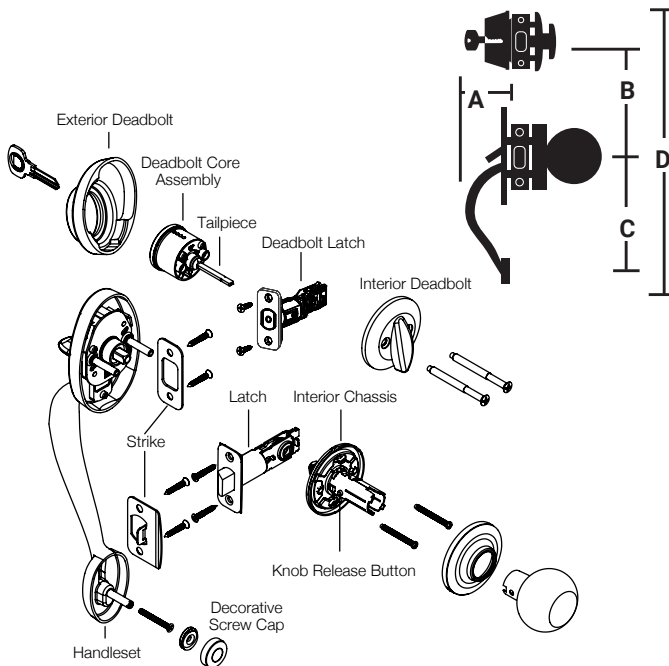

Decorative Handlesets

Price List

LIST PRICE (PRICE INCLUDES INTERIOR TRIM)

Handlesets - featuring Quick-install Design

DESIGN	FUNCTION BHMA	NO	605	625	626	609	619	620	GM Gun Metal	BSP Black Suede	613E	10BP
Homestead	Dummy	986	205.90	205.90	205.90	205.90	205.90	205.90	205.90	205.90	226.70	226.70
	Single Cylinder	926	244.40	244.40	244.40	244.40	244.40	244.40	244.40	244.40	265.20	265.20
	Double Cylinder	946	265.20	265.20	265.20	265.20	265.20	265.20	265.20	265.20	286.00	286.00
Jamestown	Dummy	987	205.90	205.90	205.90	205.90	205.90	205.90	205.90	205.90	226.70	226.70
	Single Cylinder	927	244.40	244.40	244.40	244.40	244.40	244.40	244.40	244.40	265.20	265.20
	Double Cylinder	947	265.20	265.20	265.20	265.20	265.20	265.20	265.20	265.20	286.00	286.00
McKinley	Dummy	682	171.60	171.60	171.60	171.60	171.60	171.60	171.60	171.60	192.40	192.40
	Single Cylinder	622	202.80	202.80	202.80	202.80	202.80	202.80	202.80	202.80	223.60	223.60
	Double Cylinder	642	223.60	223.60	223.60	223.60	223.60	223.60	223.60	223.60	244.40	244.40
Pedestal	Dummy	988	205.90	N/A	N/A	N/A	N/A	N/A	N/A	205.90	N/A	226.70
	Single Cylinder	928	244.40	N/A	N/A	N/A	N/A	N/A	N/A	244.40	N/A	265.20
Teton	Dummy	681	N/A	N/A	N/A	N/A	171.60	171.60	171.60	171.60	N/A	192.40
	Single Cylinder	621	N/A	N/A	N/A	N/A	202.80	202.80	202.80	202.80	N/A	223.60
	Double Cylinder	641	N/A	N/A	N/A	N/A	223.60	223.60	223.60	223.60	N/A	244.40
Rainier	Dummy	683	N/A	171.60	171.60	N/A	171.60	171.60	171.60	171.60	N/A	192.40
	Single Cylinder	623	N/A	202.80	202.80	N/A	202.80	202.80	202.80	202.80	N/A	223.60
	Double Cylinder	643	N/A	223.60	223.60	N/A	223.60	223.60	223.60	223.60	N/A	244.40
Ridgefield	Dummy	989	N/A	N/A	N/A	N/A	205.90	N/A	N/A	205.90	N/A	226.70
	Single Cylinder	929	N/A	N/A	N/A	N/A	244.40	N/A	N/A	244.40	N/A	265.20

NOTE: Handleset Interior Trim - Selection Chart Below.
Split finish not available.

INTERIOR TRIM ASSEMBLIES	ITEM	MODEL NO	LIST PRICE*
Heritage Collection Grade 2	Dummy	719	20.80
	Single Cylinder Deadbolt	720	26.00
	Double Cylinder Deadbolt	740	31.20
Heritage Collection Grade 3	Dummy	680	20.80
	Single Cylinder Deadbolt	620	26.00
	Double Cylinder Deadbolt	640	31.20
	Vidalia/Valdosta SQR Rose		34.30
	*All finishes		

AVAILABLE OPTIONS – BOX PACK ONLY		LIST PRICE UPCHARGE
Page 41	Split-Hub Latches	NC when specified
Page 37	800 Series Deadbolt Latches	NC when specified
Page 42	T-Strikes	1.50
Page 42	ANSI 4-7/8" Strike	7.10
Page 42	Deadbolt Security Strikes	0.80
Page 42	Other Lockset Strikes	NC when specified
Page 43	Additional keying options	NC when specified
Extension Kit 2 to 2-1/4" Heritage Collection Grade 2 and Grade 3 Handleset (Thick Door Pack) #YR07600		13.10 (specify finish)

Note: When ordering handlesets less interior pack, (LIP) deduct the interior trim assembly list price to determine handleset price. Specify handing when ordering all lever interior trim assemblies.

Decorative Handlesets

Price List

HERITAGE COLLECTION GRADE 2 INTERIOR TRIM

DESIGN	605	625	626	609	619	620	GM Gun Metal	BSP Black Suede	613E	10BP
Bridgeport	A	A	A	N/A	A	N/A	N/A	N/A	N/A	N/A
Cambridge	A	A	A	A	A	A	A	A	A	A
Dartmouth	A	N/A	N/A	N/A	A	N/A	A	A	N/A	A
Oxford	A	N/A	N/A	A	A	N/A	N/A	A	A	A
Academy	N/A	N/A	A	A	A	N/A	N/A	N/A	N/A	N/A
Augusta	A	N/A	A	A	A	N/A	N/A	N/A	A	A
Delaware	N/A	A	A	N/A	A	N/A	N/A	A	A	A
Kincaid	A	N/A	N/A	N/A	A	N/A	N/A	A	N/A	A
Marina	N/A	A	A	N/A	A	N/A	A	N/A	A	A
McClure	A	N/A	A	N/A	A	A	N/A	N/A	A	A
Monroe	N/A	N/A	A	N/A	A	N/A	N/A	N/A	N/A	N/A
Milan	A	A	A	N/A	A	N/A	N/A	N/A	N/A	N/A
Norwood	A	A	A	A	A	A	A	A	A	A
Pacific Beach	A	A	A	A	A	N/A	N/A	N/A	N/A	N/A
Valdosta	N/A	A	A	N/A	A	N/A	N/A	A	A	A
Valdosta SQR Rose	N/A	N/A	N/A	N/A	A	N/A	N/A	A	N/A	N/A
Virgo	A	N/A	A	N/A	A	N/A	N/A	N/A	A	A

Specify handing when ordering lever interior trim. With split finish orders, strikes match interior finishes.

A = Available as factory direct interior pack selection in Handlesets

N/A = Not available as interior pack selection in Heritage Collection Grade 2

HERITAGE COLLECTION GRADE 3 INTERIOR TRIM







DESIGN	605	625	626	609	619	620	GM Gun Metal	BSP Black Suede	613E	10BP
Cirrus	A	A	A	N/A	A	A	A	N/A	A	A
Horizon	A	A	A	A	A	A	A	A	A	A
Oasis	N/A	N/A	N/A	N/A	A	N/A	N/A	N/A	N/A	A
Terra	N/A	N/A	N/A	N/A	A	N/A	A	N/A	N/A	A
Valley	A	N/A	A	N/A	N/A	N/A	N/A	N/A	N/A	N/A
Mesa	N/A	N/A	A	A	A	N/A	N/A	N/A	N/A	N/A
Niagara	A	A	A	A	A	A	A	A	A	A
Prairie	N/A	A	A	A	A	N/A	N/A	N/A	N/A	N/A
Savannah	A	A	A	A	A	A	A	N/A	A	A
Vidalia	A	A	A	A	A	A	A	A	A	A
Woodland	A	A	A	A	A	A	A	A	A	A
SQR Rose	N/A	N/A	N/A	N/A	A	N/A	N/A	A	N/A	A

Specify handing when ordering lever interior trim. With split finish orders, strikes match interior finishes.

A = Available as factory direct interior pack selection in Handlesets

N/A = Not available as interior pack selection in Heritage Collection Grade 3

LIST PRICE

HANDLESET	DESCRIPTION	DIMENSION	CORNER SPECS	MODEL NO	LIST PRICE
LATCHES - INTERIOR	 2 3/8" Spring Latch	1 x 2 1/4"	Square Corner	YR01804*	13.20
	 2 3/8" Spring Latch	1 x 2 1/4"	Round Corner	YR01802*	13.20
SPLIT HUB SPRING	 2 3/8" Spring Drive-In Latch	1" Dia.	N/A	YR01803*	13.20
LATCHES	 2 3/4" Spring Latch	1 x 2 1/4"	Square Corner	YR01808*	13.20
	 2 3/4" Spring Latch	1 x 2 1/4"	Round Corner	YR01806*	13.20
	 2 3/4" Spring Drive-In Latch	1" Dia.	N/A	YR01807*	13.20

*Specify finish when ordering

Heritage Collection Grade 2 & Grade 3 Accessories

Strikes

LOCKSET STRIKES

ITEM	DIMENSIONS	CORNER SPECS	MODEL NO	LIST PRICE
Standard Full Lip Strike/SC	1 ³ / ₄ " x 2 ¹ / ₄ "	Square Corner	YR02001*	2.10
Standard Full Lip Strike/RC	1 ³ / ₄ " x 2 ¹ / ₄ "	Round Corner	YR02000*	2.10
T-Strike	1 ¹ / ₈ " x 2 ³ / ₄ "	Square Corner	YR02020*	3.10
ANSI 4 ⁷ / ₈ "	1 ¹ / ₄ " x 4 ⁷ / ₈ "	Square Corner	YR02030*	8.80

* Specify finish when ordering

Note: Not all finishes available

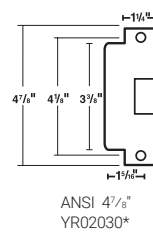
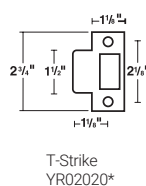
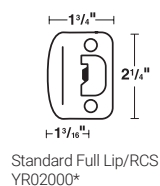
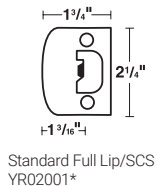

DEADBOLT STRIKES

ITEM	CORNER SPEC	MODEL NO	LIST PRICE
Standard Deadbolt Strike/SC	Square Corner	YR02082*	2.10
Standard Deadbolt Strike/RC	Round Corner	YR02080*	2.10
Security Strike 3 ⁵ / ₈ "	Round Corner	YR02081*	2.70
Security Strike 3 ⁵ / ₈ "	Square Corner	YR02083*	2.70
Full Lip Deadbolt Strike	Square Corner	YR02085*	2.10
Full Lip Deadbolt Strike	Round Corner	YR02084*	2.10
Universal Deadbolt Strike	Square Corner	YR02086*	2.10
Universal Deadbolt Strike	Radius Corner	YR02088*	2.10
White Plastic Dust Box 1" x 2 ³ / ₄ " Deadbolt (For Universal Strike)		YR026002	0.50
Universal Deadbolt Strike with Security Plate	Radius Corner	YR02089*	2.80

*Specify finish when ordering

Note: Not all finishes available

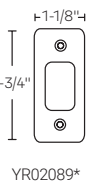
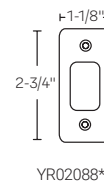
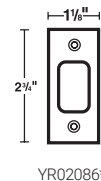
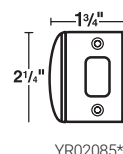
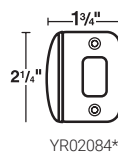
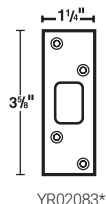
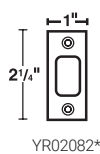
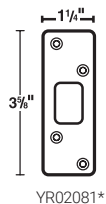
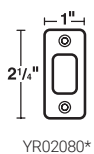

FINISH MATCH FOR LATCH, STRIKE, CYLINDER & SCREWS* Heritage Collection Grade 2 and Grade 3

Lock Finish	605	609	619	620	GM/BSP	US10BP	613E	626	625
Latch Face Plate Color	605	609	Nickel	Black	Black	Black	10BE	Nickel	Nickel
Latch Head Color	Nickel	Nickel	Nickel	Nickel	Nickel	Nickel	Nickel	Nickel	Nickel
Standard Strike Plate Color	605	609	Nickel	Black	Black	Black	10BE	Nickel	Nickel
Cylinder Color	Brass	Brass	Nickel	Nickel	Nickel	Brass	Brass	Nickel	Nickel
Screw Color	Brass	Brass	Nickel	Black	Black	Black	Black	Nickel	Nickel

* For Standard Strike & Latch Options Only

Note: All Deadbolt Latch Bolts are Nickel

Latch Filler Plate Black 035109 .70

Heritage Collection Grade 2 & Grade 3 Accessories

Keys and Keying Cylinders

ACCENTRA KEY BLANKS AND SPECIAL KEYING CHARGES

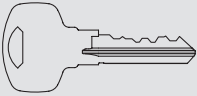
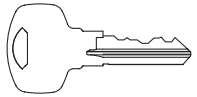
	KEY BLANK DESCRIPTION	QUANTITY	MODEL NO	LIST PRICE
	Heritage Collection Grade 2 Key Blank	50 per box	YR068003	1.50
	Heritage Collection Grade 2 6 PIN KW DO NOT COPY Key Blank	50 per box	YR068013	2.10
	Heritage Collection Grade 2 6 Pin PARA Key Blank	50 per box	YR068Y01	2.30
	Heritage Collection Grade 2 6 PIN Schlage Key Blank	50 per box	YR068009	1.50
	Heritage Collection Grade 2 6 PIN Schlage Key - cut	50 per box	YR068509	2.10
	Heritage Collection Grade 2 6 PIN Schlage DO NOT COPY Key Blank	50 per box	YR068011	2.10
	Heritage Collection Grade 3 Key Blank	50 per box	YR068004	1.40
	Heritage Collection Grade 3 5 PIN KW DO NOT COPY Key Blank	50 per box	YR068010	2.10
	Heritage Collection Grade 3 Key - cut	50 per box	YR068500	1.80
	Heritage Collection Grade 3 5 PIN Schlage Key Blank	50 per box	YR068008	1.40
	Heritage Collection Grade 3 5 PIN Schlage Key - cut	50 per box	YR068508	1.80

SPECIAL KEYING CHARGE DESCRIPTION	MODEL NO	LIST PRICE
KA - Keyed Alike	KA	NC when specified
MK - Master Keyed	MK	1.40
BK - Builder Keyed	BK	1.90
BMK - Builder Keyed and Master Keyed	BMK	3.80
GMK - Grand Master Keyed	GMK	5.20
BKGM - Builder Keyed and Grand Master Keyed	BKGM	6.20
K-T-P - Keyed To Pass	K-T-P	1.50
Extra Cut Keys	YR068550	2.10
	YR068500	1.80
Extra Cut Master Keys	YR068551	2.80
	YR068511	2.40
Extra Cut Builder Keys	YR068558	2.80
	YR068521	2.40
Stamp control number on key		1.90

Heritage Collection Grade 2 & Grade 3 Accessories

Keys and Keying Cylinders

HERITAGE COLLECTION GRADE 2 & GRADE 3 CYLINDER OPTIONS

SC-1 5-PIN STANDARD FOR Heritage Collection Grade 2 & Grade 3, 6-PIN MUST BE SPECIFIED IF NEEDED		MODEL NO	LIST PRICE
5-PIN No charge when specified with Heritage Collection Grade 3 lock - compatible with F Series			
Brass Cylinder & 2 Brass Keys, Tailpiece, Low Stack, Entry, 03		YR068401	13.30
Brass Cylinder & 2 Brass Keys, Tailpiece, Low Stack, Deadbolt, 03		YR068402	13.30
Brass Cylinder & 2 Brass Keys, Tailpiece, Low Stack, Entry, 26		YR068405	13.30
Brass Cylinder & 2 Brass Keys, Tailpiece, Low Stack, Deadbolt, 26		YR068406	13.30
6-PIN No charge when specified with Heritage Collection Grade 2 lock - compatible with A Series			
Brass Cylinder & 2 Brass Keys, Tailpiece, Low Stack, Entry, 03		YR068D01	15.20
Brass Cylinder & 2 Brass Keys, Tailpiece, High Stack, Deadbolt, 03		YR068D02	15.20
Brass Cylinder & 2 Brass Keys, Tailpiece, Low Stack, Entry, 26		YR068D05	15.20
Brass Cylinder & 2 Brass Keys, Tailpiece, High Stack, Deadbolt, 26		YR068D06	15.20
KW-1 5-PIN STANDARD FOR Heritage Collection Grade 2, 6-PIN STANDARD FOR Heritage Collection Grade 3		MODEL NO	LIST PRICE
5-PIN No charge when specified with Heritage Collection Grade 3 lock			
Brass Cylinder & 2 Brass Keys, Tailpiece, Low Stack, Entry, 03		YR060003	8.90
Brass Cylinder & 2 Brass Keys, Tailpiece, Low Stack, Deadbolt, 03		YR060103	8.90
Brass Cylinder & 2 Brass Keys, Tailpiece, Low Stack, Entry, 26		YR060006	8.90
Brass Cylinder & 2 Brass Keys, Tailpiece, Low Stack, Deadbolt, 26		YR060106	8.90
6-PIN No charge when specified with Heritage Collection Grade 2 lock			
Brass Cylinder & 2 Brass Keys, Tailpiece, Low Stack, Entry, 03		YR06D013	10.60
Brass Cylinder & 2 Brass Keys, Tailpiece, Low Stack, Select Deadbolt, 03		YR06D303	10.60
Brass Cylinder & 2 Brass Keys, Tailpiece, High Stack, Premier Deadbolt, 03		YR06D103	10.60
Brass Cylinder & 2 Brass Keys, Tailpiece, Low Stack, Entry, 26		YR06D016	10.60
Brass Cylinder & 2 Brass Keys, Tailpiece, Low Stack, Select Deadbolt, 26		YR06D306	10.60
Brass Cylinder & 2 Brass Keys, Tailpiece, High Stack, Premier Deadbolt, 26		YR06D106	10.60
PARA FOR RESIDENTIAL PRODUCT ONLY		MODEL NO	LIST PRICE
6-PIN			
Brass Cylinder & 2 Brass Keys, Tailpiece, High Stack, Entry Lever, 03		YR06Y303	15.20
Brass Cylinder & 2 Brass Keys, Tailpiece, High Stack, Entry Lever, 26		YR06Y306	15.20
Brass Cylinder & 2 Brass Keys, Tailpiece, High Stack, 83/820 Deadbolt, 03		YR06Y403	15.20
Brass Cylinder & 2 Brass Keys, Tailpiece, High Stack, 83/820 Deadbolt, 26		YR06Y406	15.20
Brass Cylinder & 2 Brass Keys, Tailpiece, High Stack, Premier Deadbolt, 03		YR06Y413	15.20
Brass Cylinder & 2 Brass Keys, Tailpiece, High Stack, Premier Deadbolt, 26		YR06Y416	15.20

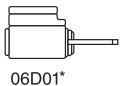

06D01*

NOTE: For Interconnects add ICN to above part numbers (Adds Longer Interconnect tailpiece)

Accessories

Rekeying

REKEYING – KEYING KITS & REKEYING PARTS

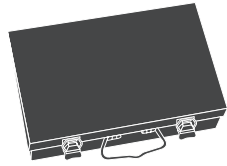

BOTTOM PIN



MASTER PIN



C-CLIP



E-CLIP
067204

E-CLIP
0672D4

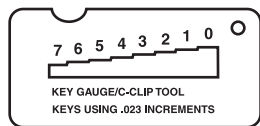

KEY CUT GAUGE



PLUG FOLLOWER

DESCRIPTION	QUANTITY	MODEL NO	LIST PRICE
ACCENTRA KW Keying Kit	Each	YR069116	116.50
ACCENTRA SC-1 Keying Kit	Each	YR069115	97.80
KW-1 Pins			
.172 – #1 Bottom Pins	100 pieces	YR065011	8.30
.195 – #2 Bottom Pins	100 pieces	YR065012	8.30
.218 – #3 Bottom Pins	100 pieces	YR065013	8.30
.241 – #4 Bottom Pins	100 pieces	YR065014	8.30
.264 – #5 Bottom Pins	100 pieces	YR065015	8.30
.287 – #6 Bottom Pins	100 pieces	YR065016	8.30
.023 – #1 Master Pins	100 pieces	YR065001	8.30
.046 – #2 Master Pins	100 pieces	YR065002	8.30
.069 – #3 Master Pins	100 pieces	YR065003	8.30
.092 – #4 Master Pins	100 pieces	YR065004	8.30
.115 – #5 Master Pins	100 pieces	YR065005	8.30
.138 – #6 Master Pins	100 pieces	YR065006	8.30
SC-1 Pins			
.165 – #0 Bottom Pins	100 pieces	YR065600	8.30
.180 – #1 Bottom Pins	100 pieces	YR065611	8.30
.195 – #2 Bottom Pins	100 pieces	YR065612	8.30
.210 – #3 Bottom Pins	100 pieces	YR065613	8.30
.225 – #4 Bottom Pins	100 pieces	YR065614	8.30
.240 – #5 Bottom Pins	100 pieces	YR065615	8.30
.255 – #6 Bottom Pins	100 pieces	YR065616	8.30
.270 – #7 Bottom Pins	100 pieces	YR065617	8.30
.285 – #8 Bottom Pins	100 pieces	YR065618	8.30
.300 – #9 Bottom Pins	100 pieces	YR065619	8.30
.030 – #2 Master Pins	100 pieces	YR065602	8.30
.045 – #3 Master Pins	100 pieces	YR065603	8.30
.060 – #4 Master Pins	100 pieces	YR065604	8.30
.075 – #5 Master Pins	100 pieces	YR065605	8.30
.090 – #6 Master Pins	100 pieces	YR065606	8.30
.105 – #7 Master Pins	100 pieces	YR065607	8.30
.120 – #8 Master Pins	100 pieces	YR065608	8.30
.135 – #9 Master Pins	100 pieces	YR065609	8.30
Standard Top Pin	100 pieces	YR065008	8.30
Standard Top Pin (82,84 Deadbolts)	100 pieces	YR0650D8	8.30
ACCENTRA Builder Key Balls	100 pieces	YR067050	12.50
Cylinder Springs (High Stack)	100 pieces	YR067001(DBLT)	5.20
Cylinder Springs (Low Stack)	100 pieces	YR067002(ENT)	5.20
C-Clips	100 pieces	YR067201	5.20
E-Clips (#820,840,83,85 Deadbolts)	100 pieces	YR067204	18.70
E-Clips (#82,84 Deadbolts)	100 pieces	YR0672D4	18.70
E-Clips (PARA Deadbolts, Cyl 820/83)	100 pieces	YR0672Y6	18.70
E-Clips (PARA Deadbolts, Cyl Premier)	100 pieces	YR0672Y5	18.70
Spring Retainer Caps (low stack)	100 pieces	YR067101	12.50
Spring Retainer Caps (high stack)	100 pieces	YR067102	12.50
Key Cut Gauge/C-Clip Tool	Each	YR069012	5.20
Plug Follower	Each	YR069001	5.70
Heritage Collection Grade2/3 Entry tailpiece	100 pieces	YR067304	19.80
Single Cylinder Tailpiece	100 pieces	YR067307	62.40
Double Cylinder Tailpiece	100 pieces	YR067308	62.40
Interconnected Cylinder Tailpiece	100 pieces	YR067307ICN	62.40

ACCENTRA

ASSA ABLOY

ASSA ABLOY ACCENTRA™

225 Episcopal Road
Berlin, CT 06037 USA
Tel 1-855-686-2204
Fax 1-800-338-0965

Customer Service Email:

customerservice.accentrares@assaabloy.com

Technical Product Support Email:

techsupport.accentra@assaabloy.com

Order Entry Email:

orders.accentrares@assaabloy.com

THE ASSA ABLOY ACCENTRA™ BRAND, with its unparalleled global reach and range of products, reassures more people in more countries than any other consumer locking solution.

THE ASSA ABLOY GROUP is the world's leading manufacturer and supplier of locking solutions, dedicated to satisfying end-user needs for security, safety and convenience.

Other products' brand names may be trademarks or registered trademarks of their respective owners and are mentioned for reference purposes only. These materials are protected under US copyright laws. All contents current at time of publication. ASSA ABLOY Residential Mechanical reserves the right to change availability of any item in this price book, its design, construction and/or its materials. Copyright 2024. ASSA ABLOY Residential Mechanical. All rights reserved. Reproduction in whole or in part without the express written permission of ASSA ABLOY Residential Mechanical, is prohibited.

4200-0310-02/24